

# Gorham Model Products

1990

*Catalog*

THE WORLD'S FINEST RADIO CONTROLLED HELICOPTERS



FIRST IN PERFORMANCE

FIRST IN SERVICE

FIRST IN THE WORLD

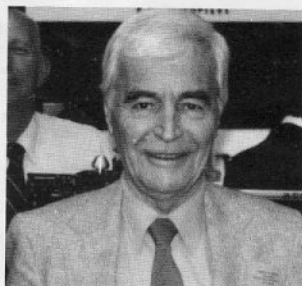
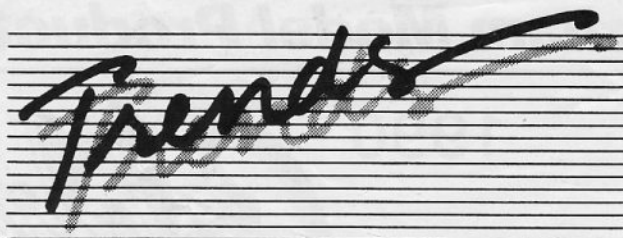

## A MESSAGE FROM JOHN GORHAM

---

1988 and 1989 are, to say the least, very eventful and exciting years for **GMP**. To preserve our lead position in the R/C helicopter market, we designed and produced **LEGEND** - a totally new .60 sized, versatile helicopter available in many different versions (see inside for further details).

We fully expected **LEGEND** to be competitive with the many other .60 sized helicopters now available on the market. We are very pleased, however, that **GMP** machines won first place in every category of the 1989 USA Nationals. Most of the wins were made with our new **LEGEND** and the top position of the FAI class was obtained by Curtis Youngblood who used **LEGEND**'s new "Elite" contest rotor head on his **GMP** **COMPETITOR**. The icing on the 1989 cake however was when **GMP** helicopters took 3rd, 5th and 7th places in the 1989 Worlds Championships - beaten only by a very well trained Japanese team.

We are especially proud of the "Elite" Rotor Head. This new rotor head is designed and made in the USA from high quality "steel and aluminum". **LEGEND** with its new "Elite" rotor head has also won nearly all the European contests it has entered with Len Mount as its pilot.

Our best achievement for 1988-89, though, has to be our new .40 powered **REBEL** helicopter, also designed and manufactured in the USA. **REBEL** is expressly aimed at the entry level customer and especially the fixed wing pilot who wants to try R/C helicopters but does not want to initially invest \$1,000's of dollars on the kit, special radio and special engine needed. **REBEL** will fly with a standard airplane engine and a standard airplane 4 channel radio. So owning a **REBEL** will cost the new entrant flier a modest \$250.

Our **CRICKET** and **COBRA** helicopters still continue their amazing sales success history. Our story for 1989 would not be complete without mentioning that none of our growth and success would be possible without the cooperation and assistance of the 1,000 USA hobby stores that keep our customers supplied from day to day.

Finally during 1988 and 1989, we have experienced problems with a growing gray market activity of Hirobo products. Our response to this activity is to increase our efforts to make **GMP** an all-American company manufacturing and distributing top quality, world beating R/C helicopters and accessories. The more exclusively American we are, the better and more consistent our support to you, our customer, will become. We hope our present and future products will attract you enough to assist us in our goal.

---

***GMP... TAKING R/C HELICOPTERS TO NEW HEIGHTS!***

## DESIGN

Most of GMP's RC helicopters are designed and manufactured in the USA. Cricket, Hughes, Rebel, and Legend are totally designed and manufactured by us. GMP's design facilities are in-house and staffed by professionals. Additional efforts needed are provided by top ranking industry consultants. GMP's talents were recently utilized by the U.S. military to design and build large size target and drone helicopters involving fully automatic flight control. The manufacturing rights of the 1/5 scale Drone have been granted by GMP to Boeing of Canada. Ltd. For 1989-90 GMP has in production REBEL, an inexpensive 40 size beginner helicopter with several industry first features and the new 'Elite' FAI contest helicopter. Elite is proving to be the finest contest helicopter in the world as it dominated the 1989 Nats by placing 1st in every category and took 3 out of the top 7 places in the 1989 Worlds Championships.

## R & D

No high technology company such as GMP can survive and grow without continuous research and development. GMP has built and maintains special facilities to enable constant efforts to be expended in improving the design features of current helicopters and in preparing the prototypes for future production and sales to you - our customer. Problems which may arise with our products are evaluated and solved in our R & D facilities. Design improvements are passed on to the design and production departments for the earliest incorporation in our kits. The GMP R & D group also provides test building and rigorous flight evaluation of all our products before they are released for production. As a result, GMP kits enjoy the reputation of having the finest building instructions and the best flight performance in the industry. Our R & D facilities are currently engaged in on-going development of the REBEL beginner helicopter, Legend Elite contest helicopter, and a new line of radical rotor blades and paddles featuring the latest full-size rotor blade technology.

## MANUFACTURING

GMP possesses its own complete in-house machine shop facilities and manufactures all prototype helicopters for evaluation by its own design and R & D groups and other selected fliers. Sub-assembly of the mechanical units used in producing of GMP helicopter kits is performed in-house. All vacuum formed plastic parts are produced in the GMP facilities. Large volume machined and sheet metal parts are designed and drawn in-house and then sub-contracted out to one of more than 80 sub-contractors that regularly manufacture/supply GMP parts and supplies. A double inspection technique is standard on the sub-assemblies and packing of GMP parts and kits. Some of our major sub-contractors have been part of the GMP team for over nine years now. Consequently, GMP's work gets high priority attention.

## SERVICE

The seal of success on any kit manufacture such as GMP is the quality and extent of its after-sales support. A plentiful and uninterrupted supply of parts call for a very large and expensive inventory. GMP holds, in-plant, a stock of over \$1.7 million of parts and accessories for all its helicopters. Fast, friendly, and trouble-free supply of these parts is assured by the Calabasas, California, USA depot. This facility has several technicians/fliers who can provide answers to your questions. In addition, GMP will soon be opening an Eastern distributor of major GMP kits and parts to allow for quicker delivery to our Eastern customers. Parts are also now widely available in more than 1,000 hobby stores nationwide. These stocking hobby stores are growing daily. Our order desks have special 800 lines for dealers to expedite their orders which are normally processed by us the day they are received. They are shipped by UPS, Federal Express or any one of the other carriers - all of whom serve the Los Angeles area. All incoming and outgoing foreign shipments are handled by GMP's own brokers in Los Angeles. GMP produces and ships between 700 and 1,000 helicopters every month! GMP has and will maintain the finest service in the industry.

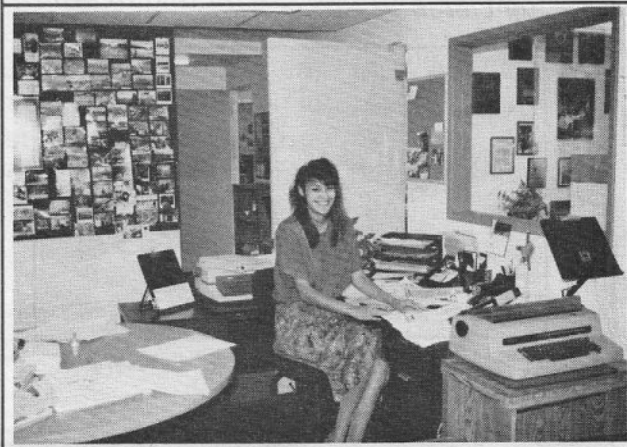
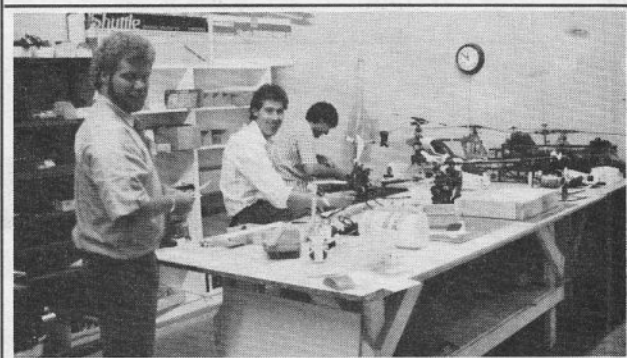

# FEATURES OF GMP HELICOPTERS

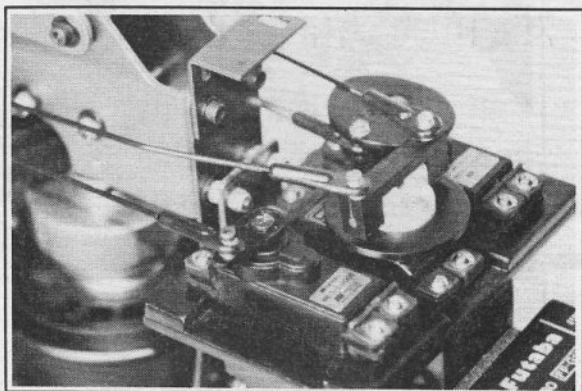

*Compact & versatile radio installation*

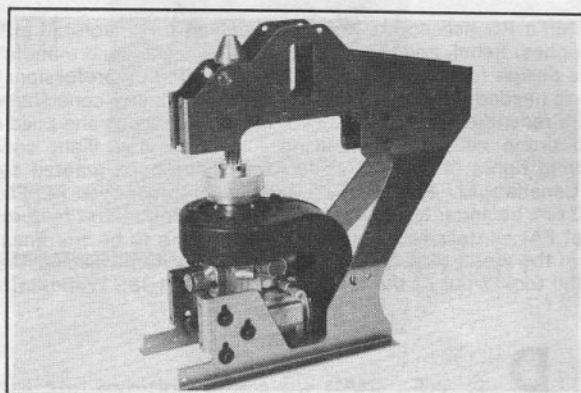

*Precision clutch fan & chassis design*



*All metal high performance rotor head*

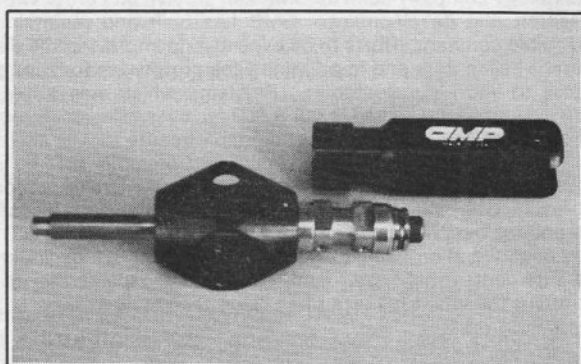

*Heavy duty triple ball bearing main rotor with oversized thrust bearing*

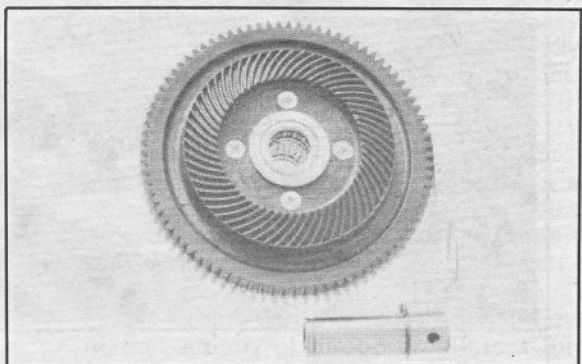

*Autorotations are easy with multiple bearing clutch*

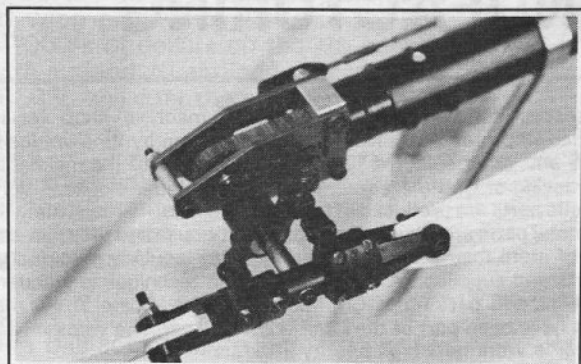

*Triple ball bearing, belt driven tail rotor system*

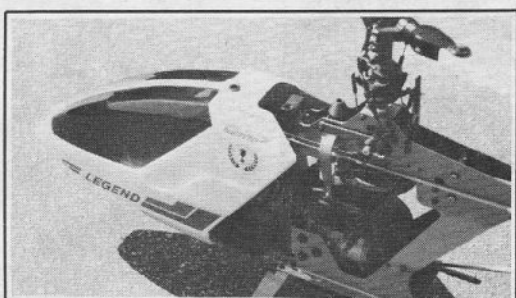

*Quick & easy "slide-lock" canopy attachment*

**FOR TOP PERFORMANCE AND  
OUTSTANDING RELIABILITY  
CHOOSE GMP AND WIN!**

# FEATURES OF GMP HELICOPTERS

## FINEST QUALITY INSTRUCTION MANUALS!

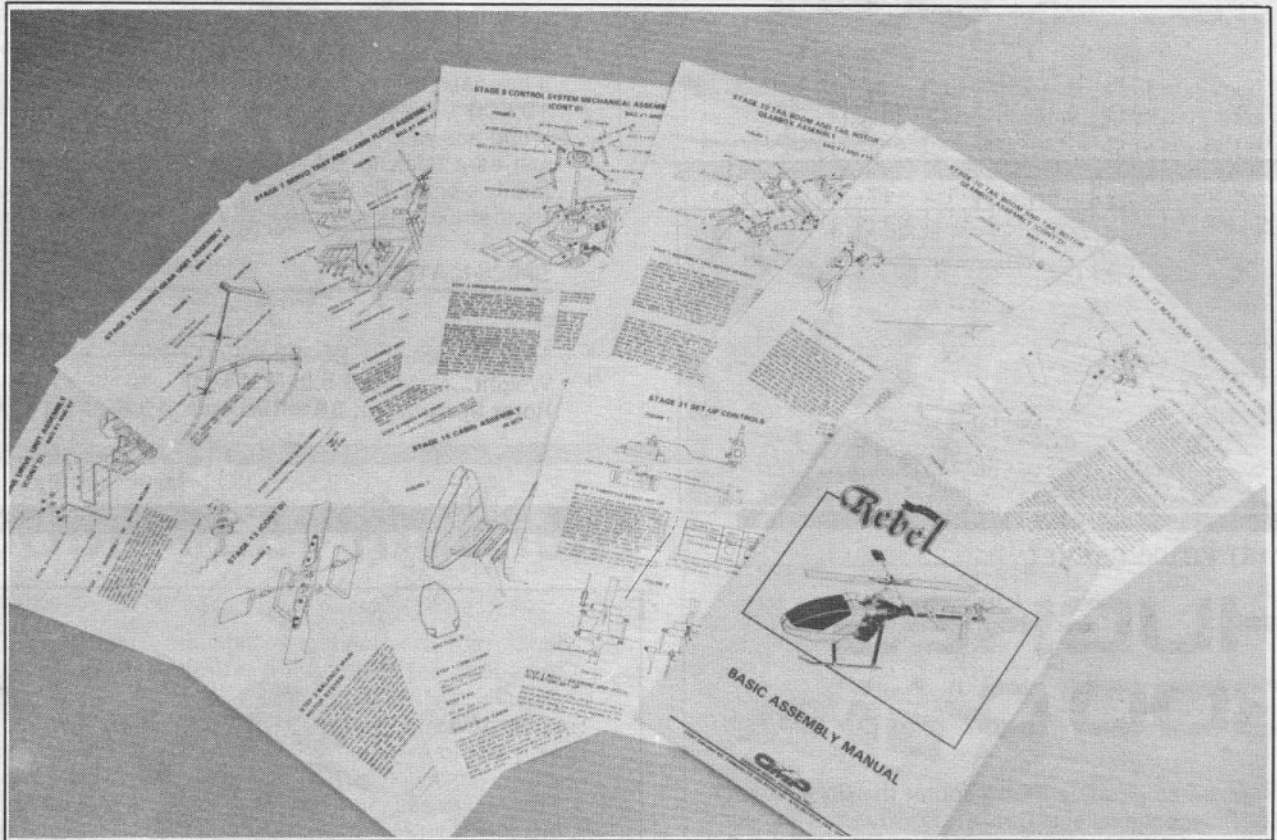

GMP helicopters are regarded as having the most complete, easy to follow, and informative instruction manuals in the industry. Many hours are spent by the GMP staff structuring the various steps and procedures so that the complete novice can successfully assemble and fly a GMP helicopter with the minimum expenditure of effort and time.

GMP utilizes a complete in-house art and publishing department to visually demonstrate all construction sequences in a professional manner. Before any kits are placed into production, complete helicopters are assembled by beginners using the manual to ensure clarity. Most important, the staff at GMP listens to you, the customer, regarding any changes or updates that will make things clearer and easier to understand.

# COMPLETE HELICOPTER KITS



## CRICKET

This is the one that started it all! Designed in 1979, it has been selling consistently ever since. More than 15,000 Crickets have been delivered all over the world and many are still being flown as a trainer or just as a relaxing small helicopter to take along on family picnics. Excellent low-cost entry level helicopter that exhibits great stability and maneuverability.

### SPECIFICATIONS:

Engine Size..... .28-.32 cu in  
Weight.....4.6-5.5 lb (2.4 kgs)  
Rotor Span.....38 in (96 cm)

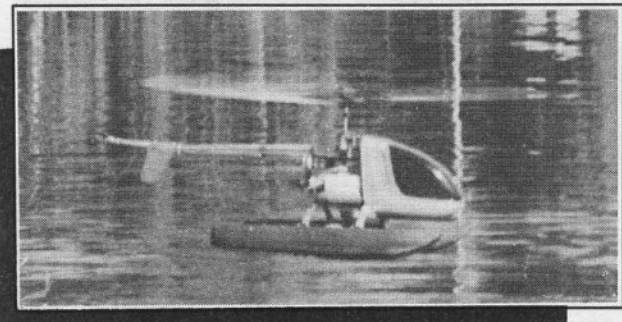

PART # C100 CRICKET

## HUGHES 300 C

A unique small scale RC helicopter the GMP Hughes 300C uses the reliable Cricket transmission and controls in a very scale-like arrangement. The 0.25-0.32 powered Hughes 300C is available as a complete kit or as a conversion kit for Cricket owners. Not recommended for complete beginners.



PART # H300 HUGHES 300C Complete Kit



### SPECIFICATIONS:

Engine Size..... .40-.60 cu in (6.5 - 10 cc)  
Weight.....7 to 8 lb (3.5 kgs)  
Rotor Span.....50 in (127 cm)  
Radio Required.....4-5 channel 4-5 servo

## COBRA

Cobra is a 40-60 powered, fully aerobatic RC helicopter, specifically designed to be suitable for beginner, intermediate and expert fliers. Hovering and forward flight stability is unsurpassed while aerobatic performance is nothing short of breathtaking. Cobra can perform all AMA and FAI aerobatic maneuvers. Cobra is the result of many years of design and development by GMP. The final product exemplifies extensive development and state-of-the-art production. Available with or without autorotation.

PART # 800 COBRA

PART # 800A COBRA w/autorotation

# COMPLETE HELICOPTER KITS



PART #800KCA KING COBRA

## KING COBRA

King Cobra is a .60 cu in powered contest version of the ever-popular Cobra helicopter. All black anodized, the King Cobra includes the "Pro" head, as used to win countless competitions including the World Championships. Autorotation is a standard feature on the King Cobra in addition to extra high quality ball bearings for that contest winning performance. King Cobra is longer than Cobra by 3.5 inches to allow the use of the larger diameter rotor blades used by many contest fliers.

### SPECIFICATIONS:

Engine Size..... .60 cu in  
Weight.....9.3 lb (4.2 kgs)  
Rotor Span.....55 in (140 cms)  
Radio Required.....4-5 channel 5 servo

## COBRA JET RANGER

The contest winning qualities of the GMP Cobra/Legend are further improved by the addition of GMP's superb scale epoxy fiberglass Jet Ranger Fuselage. The GMP Jet Ranger has been selected by the A.M.A. to be one of the 3 members of the USA team for 3 consecutive World Championships, including 1989. In addition, the Jet Ranger has established an unexcelled contest record by placing 1st and 5th in the 1987 World Championships held in Bern, Switzerland, and placed 1st and 2nd in the 1985, 1986, 1987 & 1989 US Nationals. An excellent enhancement for your Cobra when you are ready to handle it's sparkling performance. Made in California -- light weight, budget priced!! Undoubtedly the most popular scale fuselage available. GMP's Jet Ranger is also available as a complete kit of the Cobra helicopter and the Jet Ranger fuselage.



PART #800 JR JET RANGER Fuselage  
PART #800JRL JET RANGER Fuselage W/Scale Landing Gear  
PART #800JMA JET RANGER W/Cobra Mechanics and Scale Landing Gear  
PART #662 Scale Landing Gear



**FLY SCALE  
COMPETITIVELY  
WITH THE JET  
RANGER**

# COMPLETE HELICOPTER KITS

## GMP **LEGEND** SERIES

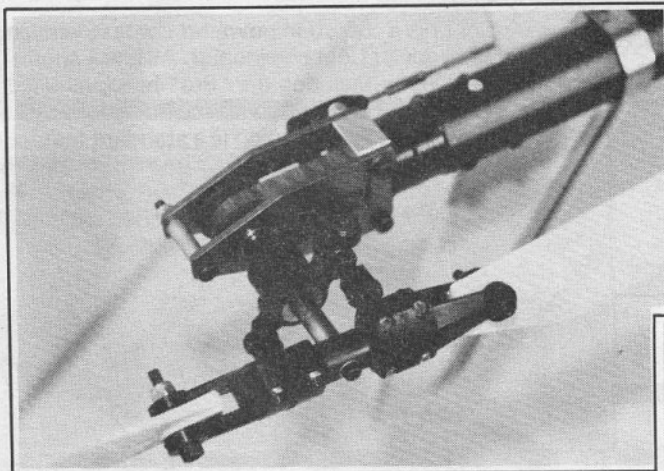

GMP's Flybarless and 'ELITE' rotor heads will fit directly to any Legend except #900PTB which requires the use of replacement main rotor shaft #9515. Custom and Pro heads must be used with main rotor shaft #815A on every version except #900PTB.

### GMP'S LEGEND IS AVAILABLE IN THE FOLLOWING VERSIONS:

**#900FTB** - flybarless rotor head, belt drive tail, fully ball bearinged.

A flybarless 'animal' with breathtaking fast and very aerobatic performance. This version has the new, very 'space age' yet reliable, toothed belt tail drive system. Autorotation is standard.

**#900ETB** - Elite rotor head, belt drive tail fully ball bearinged.

A world class contest pod and boom ship fitted with GMP's super performance, contest series 'ELITE' rotor head and tooth belt tail drive system. Autorotation is standard.

**#900PTB** - Pro rotor head, belt drive tail, fully ball bearinged.

A smooth aerobatic performer with GMP's world renowned 'Pro' rotor head and toothed belt tail drive.

**#900TB** - belt drive tail, but no rotor head.

Legend with toothed belt tail drive. Comes without a rotor head so you may fit your own existing GMP rotor head or the 'ELITE' rotor head for F.A.I. performance.



**#900TG** - gear driven tail drive, but no rotor head.

Gear driven tail rotor as utilized by the Cobra/Competitor series. Comes without a rotor head so you may fit your own existing GMP rotor head.

### LEGEND STATISTICS

POWER	46-61 cu in 7.5-10cc
MAIN ROTOR SPAN	55-58" (140-147cms)
TAIL ROTOR SPAN	10" (25.4 cms)
ENGINE TO MAIN ROTOR RATIO	8.6 to 1 (9.5 to 1 optional)
MAIN ROTOR SPEED (RECOMMENDED)	1750 rpm
TAIL ROTOR TO MAIN ROTOR RATIO	4.75 to 1 (Belt drive)
HEIGHT	18" (45.75 cms)
LENGTH (EXCLUDING MAIN ROTOR BLADES)	50" (127 cms)
WEIGHT (DRY)	8.8 lbs (3.85 kgs)
(WITH GYRO, 1000 ma PACK, 61 ENGINE & MUFFLER)	
RADIO INSTALLATION	5 servos
GYRO	Recommended



# COMPLETE HELICOPTER KITS

## GMP **LEGEND** SERIES



### WHY IS THE GMP LEGEND THE WORLD'S MOST SUCCESSFUL HELICOPTER?

#### SIMPLE, INNOVATIVE DESIGN

- LIGHTWEIGHT, TOOTHED BELT DRIVEN TAIL ROTOR, LESS MOVING PARTS
- PRECISION TAIL ROTOR PITCH CONTROL, MORE ACCURATE RESPONSE
- "SLIDE-LOC" CANOPY MOUNT, QUICK & EASY ATTACHMENT
- FULLY ASSEMBLED MODULAR SERVO TRAY, LESS BUILDING TIME

#### UNSURPASSED QUALITY & RELIABILITY

- CONTEST QUALITY MECHANICS
- SPECIAL ALLOY HEAVY DUTY MAIN FRAMES
- ALL CONTROL LEVERS & SHAFTS BALL BEARINGED FOR SMOOTHER RESPONSE & LONGER LIFE
- THRUST BEARINGS ON MAIN SHAFT, MAIN ROTOR HEAD & TAIL ROTOR SYSTEM, AN INDUSTRY FIRST!
- LEGENDARY COBRA/COMPETITOR DRIVE SYSTEM
- ALL METAL, FULLY ASSEMBLED ROTOR HEAD, MORE CONSISTENT PERFORMANCE
- TRIPLE BALL BEARING TAIL ROTOR SYSTEM, ANOTHER INDUSTRY FIRST!

#### VERSATILITY

- LEGEND CAN BE FLOWN IN 10 DIFFERENT CONFIGURATIONS TO FIT ALL PILOTS AND MOODS
- THREE DIFFERENT ROTOR HEADS TO CHOOSE FROM (PRO, FLYBARLESS, ELITE)
- BELT OR GEAR DRIVEN TAIL ROTOR

#### CONTEST WINNING PERFORMANCE

- 1ST PLACE ALL CATEGORIES 1989 NATIONALS
- 1ST PLACE MANY LOCAL, STATE, AND EUROPEAN CONTESTS
- TOP AMERICAN PLACES IN 1989 WORLD R/C CHAMPIONSHIPS
- FANTASTIC "HOT DOG" AEROBATIC CAPABILITIES WITH ULTRA STABLE HOVER
- FULLY COMPATIBLE FOR WORLD CLASS COMPETITION
- BEST AUTOROTATIONS IN THE INDUSTRY

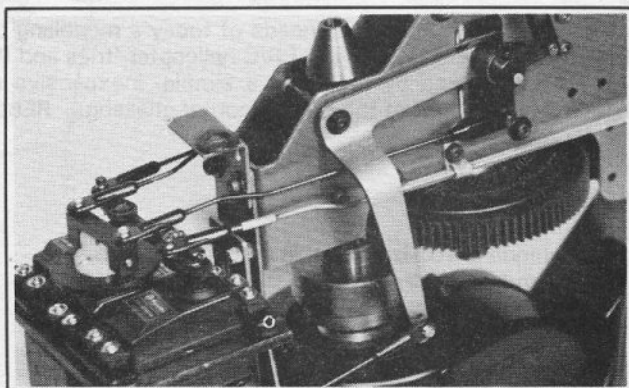

# COMPLETE HELICOPTER KITS



GMP rate gyro  
# 671 K  
Training gear  
#615  
(see Set-up &  
Field accessories)

NEW!

# Rebel

## ENTRY LEVEL HELICOPTER

REBEL has been designed to provide the new entrant into R/C helicopter flying with the lowest initial cost to try the 'challenge' of flying an R/C helicopter.

### It's Different

The R/C helicopter today is a remarkable advance over those available a short fifteen years ago. Then, most helicopters were fixed pitch, no autorotation, could use simple airplane style engines and standard 4 channel radios. These helicopters, 'Helibaby', 'Revolution 1' and 'Cricket', were simple to build, inexpensive, rugged, low cost to maintain and were the helicopters which most of today's fliers 'teethed' on.

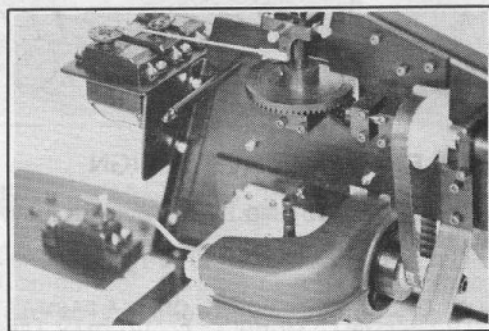

PART # R450

After carefully surveying the needs of today's modelling community, GMP decided the 'new wave' of R/C helicopter 'tries and fliers' would best be encouraged by providing a simple, inexpensive machine to allow a low cost 'try' at the R/C helicopter challenge. REBEL is GMP's answer to that need.

### REBEL:

- Uses standard 40 sized airplane engines
- Uses standard airplane fuel
- Uses standard electric airplane 'spinner' starting
- Uses standard low cost airplane radios
- Has low initial cost
- Has low cost replacement parts
- Has simple yet rugged construction
- Is very stable and easy to fly

### REBEL'S SPECIFICATIONS

Main Rotor Span	_____	42 inches
Tail Rotor Span	_____	10 inches
Length	_____	42 inches
Weight	_____	6 to 6.5 lbs.
Radio	_____	Airplane 4 channel
Engine	_____	0.40 to 0.50 cu. in.

# Rebel

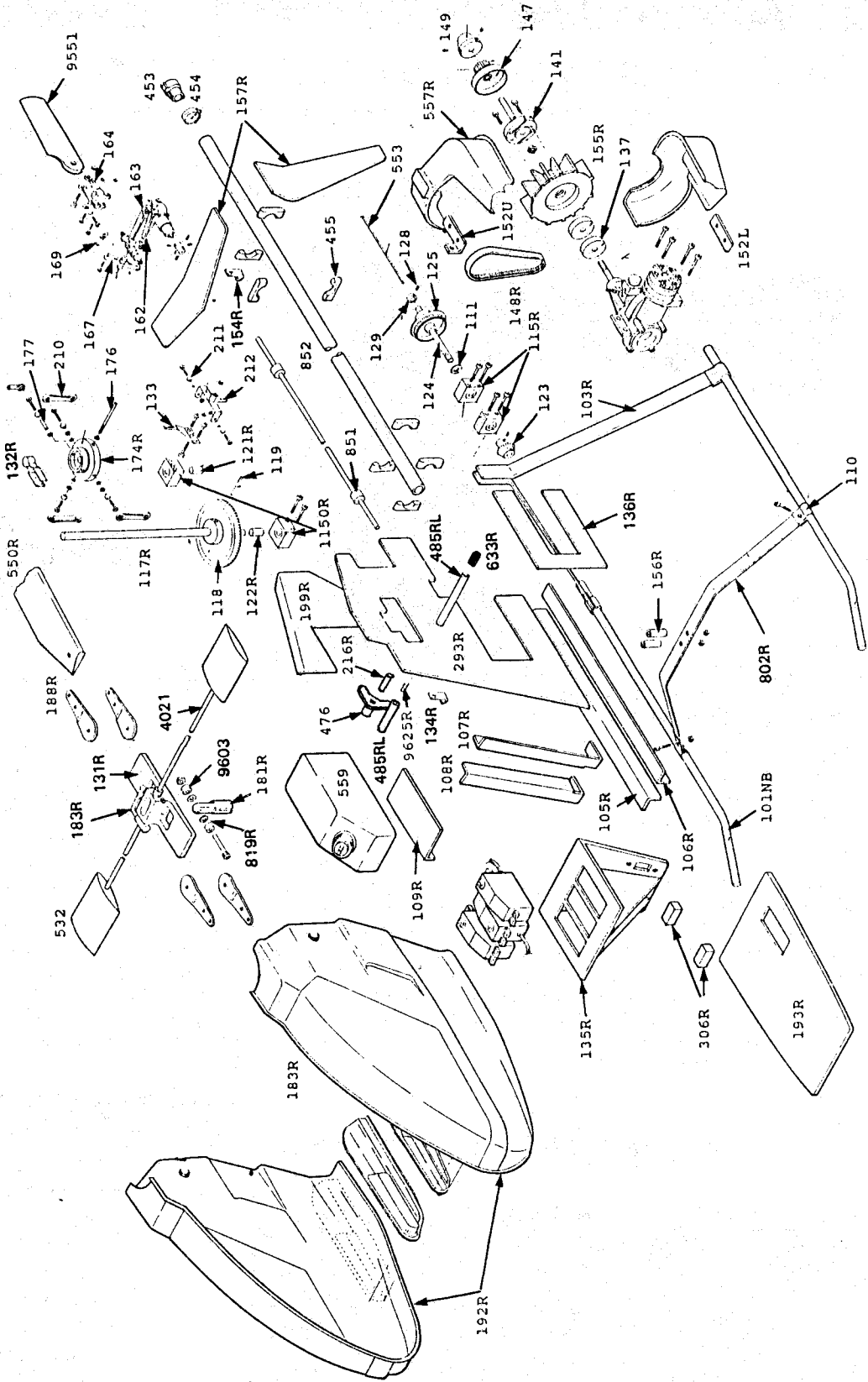

GORHAM MODEL PRODUCTS, INC. 23961 Craftsman Rd., Calabasas CA USA 91302 (818) 992-0195



# COMPLETE HELICOPTER KITS

## WORLD CLASS CONTEST 'ELITE' ROTOR HEAD

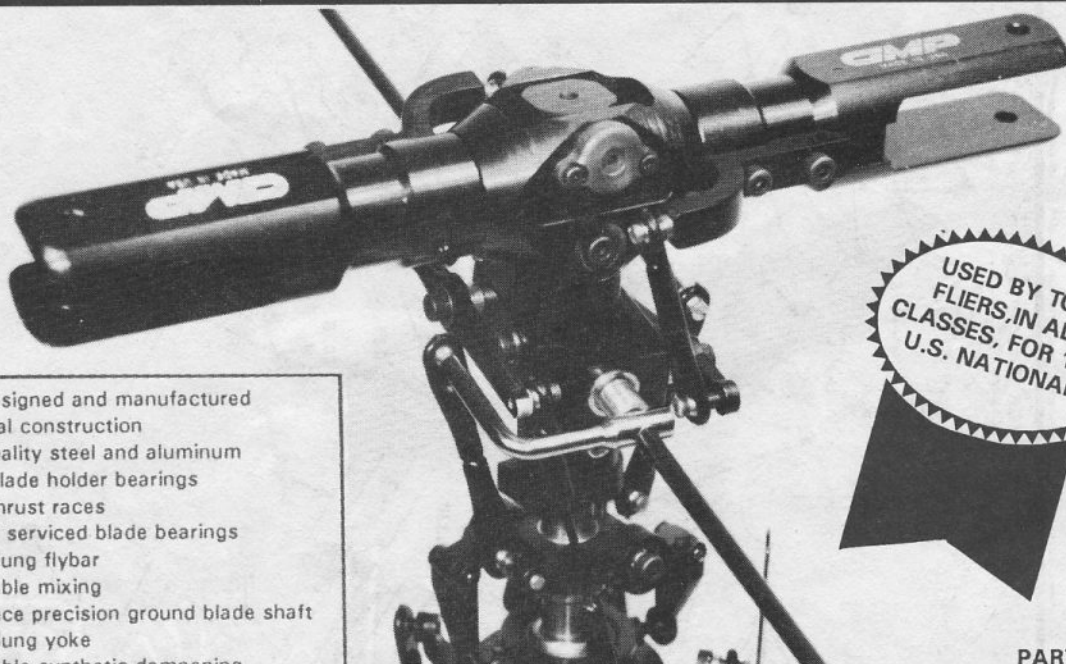

- USA designed and manufactured
- All metal construction
- High quality steel and aluminum
- Triple blade holder bearings
- Large thrust races
- Quickly serviced blade bearings
- Underslung flybar
- Adjustable mixing
- One piece precision ground blade shaft
- Underslung yoke
- Adjustable synthetic dampening
- Factory assembled, adjusted and tested

USED BY TOP  
FLIERS, IN ALL  
CLASSES, FOR 1989  
U.S. NATIONALS

PART #900EH

For ten years GMP has been experimenting with many different rotor head configurations and has finally arrived at a design which will satisfy the exact needs of the World Class contest fliers. The fact that a GMP helicopter won the 1987 World Championships is an indication that our research and development has had some success in the past. However, since 1987, the performance standards of the world's fliers has continued to improve to the point where even very small improvements in rotor head design will provide the 'razor edge' in the right hands.

Since consistency of performance is of paramount importance, GMP elected to use all metal (steel and aluminum) in the construction of their new rotor head instead of plastic which has proved to be less consistent in mechanical characteristics and hence performance especially under temperature variations.

All of GMP's research and development culminated in 1989 with a design incorporating all the results of their (and many top fliers) ideas and flight tests. The outcome is a new contest head with unique construction and quality. Although designed specifically as a 'top of the line' rotor head for the World class flier, GMP's new head is available to all fliers and can be retrofitted to many GMP helicopters - Cobra, Competitor and Legend.

The Elite rotor head is standard on the Legend 900ETB. This combination will excel all other pod and boom helicopters in sparkling, accurate and consistent contest performance. The new Elite head also provides significantly improved hovering performance in gusty conditions.



The new Elite head is individually assembled and tested before delivery - if you must have top quality performance or just want to own and fly the best, choose the GMP LEGEND WITH THE 'ELITE' ROTOR HEAD

PART #900ETB

# Elite by



## WORLD'S FINEST R/C HELICOPTER ROTOR HEAD

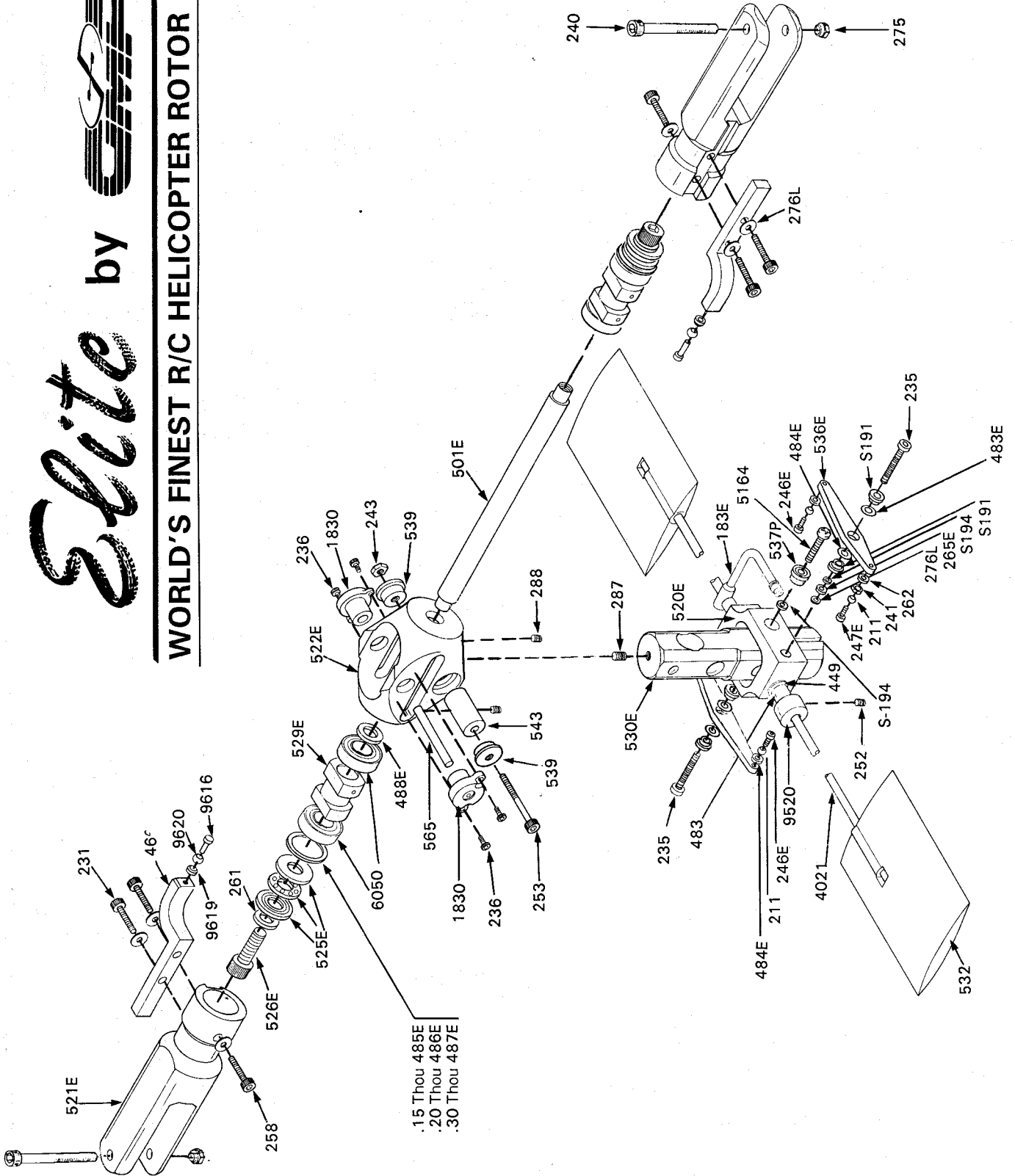

MADE IN USA

# LEGEND CONVERSION KITS

## LEGEND

### CONVERSION KITS FOR COBRA, KING COBRA & COMPETITOR

Due to the extreme world-wide popularity and many advanced features of the Legend RC helicopter, GMP is offering conversion kits to convert your Cobra, King Cobra and Competitor RC helicopters to Legend using some of your existing parts in addition to the Legend parts supplied in these conversion kits.



**PART #900CB** Cobra Conversion Kit  
**PART #900CBA** Cobra w/auto Conversion Kit

### KING COBRA CONVERSION KIT

#### Kit Includes:

- Legend swept landing gear.
- Belt drive tail assembly and high-tech rotor set-up with triple ball bearing blade holders and tail rotor blades.
- Legend main frames.
- Cyclic and collective control assembly w/servo tray.
- Legend low-drag canopy.
- "Magnalite" stabilizer set.
- Thrust bearing for main rotor shaft.
- All necessary bearings, control rods, and hardware.
- Instruction manual and tools.



**PART #900CP** Competitor Conversion Kit



### COBRA CONVERSION KITS

#### Kit Includes:

- Legend swept landing gear.
  - Belt drive tail assembly w/high tech tail rotor control set-up and triple ball bearing blade holders with blades.
  - Legend main frames.
  - Cyclic and collective control assembly w/servo tray.
  - Legend low-drag canopy.
  - "Magnalite" stabilizer set.
  - Autorotation unit with thrust bearing and main rotor shaft.
  - All necessary bearings, control rods, and hardware.
  - Instruction manual and tools.
- (The conversion kit for Cobra without autorotation<sup>1</sup> includes an autorotation unit. PART #900CB)



**PART #900KC** King Cobra Conversion Kit

### COMPETITOR CONVERSION KIT

#### Kit Includes:

- Legend flywheel and fan assembly.
- Legend main rotor shaft.
- Legend swept landing gear.
- Belt drive tail assembly and high-tech tail rotor set-up with triple ball bearing blade holders and tail blades.
- Legend main frames.
- Cyclic and collective control assembly w/servo tray.
- Legend low drag canopy.
- "Magnalite" stabilizer set.
- Thrust bearing for main rotor shaft.
- All necessary bearings, control rods and hardware.
- Instructions manual and tools.

# GMP ROTOR HEADS

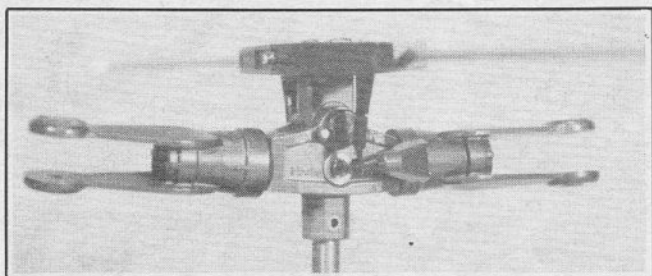

PART #900CH

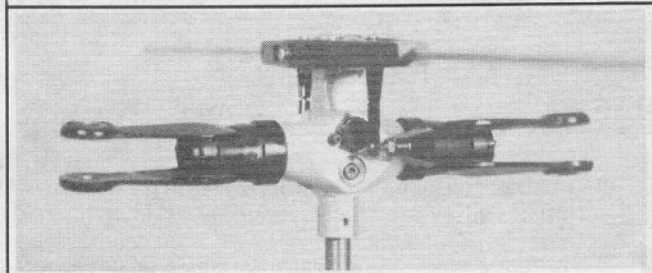

PART #900PH

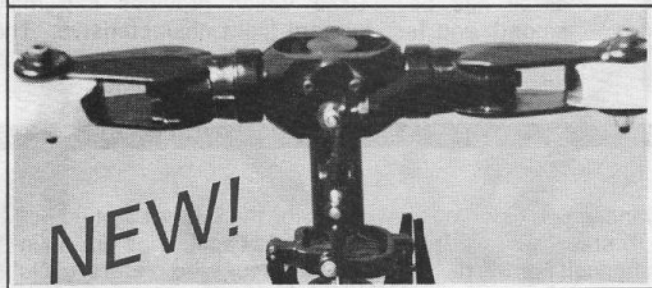

PART #900FH

## CUSTOM HEAD

GMP's well known and simple Custom head is available on the ever popular and upgraded 'Cobra Custom' 50-60 powered machine. This head provides collective pitch, 'Bell-Hiller' feed back, with a very stable yet aerobatic performance. A very good choice for the new fliers first collective pitch machine. The Custom Head can also be used on King Cobra (#800KCA), and comes standard with Cobra Scale Mechanics kits (#800M and #800MA).

## PRO HEAD

Choice of Championships! GMP's most popular contest and sports head in the world today. Provides smooth hovering capabilities and breathtaking aerobatics. Pro head is used on King Cobra (#800KCA), (#500A), and Legend-flybar version (#900PTB). It can also be fitted directly to Cobras (#800 and #800A), Cobra Scale Mechanics kits (#800M and #800MA), and Legend-flybarless version (#900TB). Main rotor shaft (#815A) is necessary when fitting the Pro head on the flybarless Legend.

## FLYBARLESS HEAD - ASSEMBLED

GMP's technically advanced, all metal flybarless rotor head has three ball bearings in each blade holder and precision machining all over. 'Delta 3' feed back makes this head the first choice of the 'hot dogger', the sports flier and any reasonable competent flier who wants to fly something new and different. GMP's new flybarless head provides tighter aerobatics, faster forward speeds and 'out of this world' autorotation capability. The flybarless rotor head comes standard with Legend-flybarless version (#900TB) and can be fitted to Cobras (#800 and #800A), King Cobra (#800KCA), with addition of Legend main rotor shaft (#9515).

## 'ELITE'

## FAI CONTEST HEAD - ASSEMBLED

After many years of factory flight testing and field experience, GMP has finally decided to produce what it, and many of the worlds top fliers, believe to be the finest contest rotor head in the world. Made of the highest quality aluminum and steel, the Elite rotor head features an underslung flybar and completely 'slopless' moving parts. Simple, yet very effective. The GMP Elite rotor head is manufactured in the USA for all the world's top fliers to use World Championship class at an affordable price. When you want to move up to the very best, choose GMP's new Elite rotor head.



PART #900EH

# GMP ROTOR BLADES

Today's RC helicopters have become highly sophisticated in terms of the engine drive and control systems, rotor heads, and special radios. They are capable of performing precision hovering and advanced aerobatic maneuvers, but their flight envelopes have still not been fully explored.

With all of these advancements, one area that significantly influences the flight characteristics of the helicopter and has not yet been fully assessed is the design of the main rotor blades. It is true that the development and incorporation of C.G. corrected, weighted blades have greatly improved flight characteristics for the expert class, but more attention is still needed to define optimum geometry, improved airfoil sections, pivot bolt locations, etc.

Recognizing this, GMP, in cooperation with Tech Specialities, have been actively involved in rotor blade design and flight testing for the past two years. This effort has culminated in a new line of rotor blades for the GMP range of helicopters.

These new generation rotor blades are available pre-slotted with correct weights included and set-up/balancing instructions also provided with each set of blades. The new GMP blades are constructed of a specially selected hardwood leading edge and a lighter balsa trailing edge. This maintains the C.G. at the correct location across the airfoil chord which eliminates many unwanted blade flutter problems. Total blade weight is also carefully controlled as each set is carefully matched for equal weight.

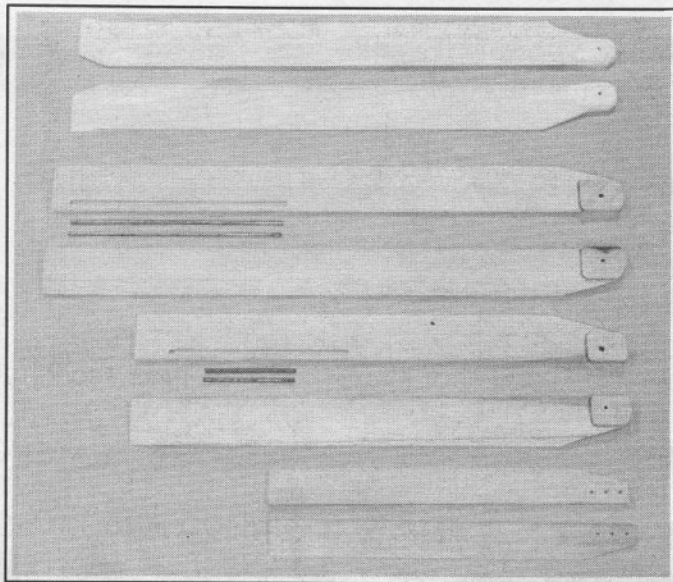

GMP's special contest blades feature a modern symmetrical airfoil for smoother collective response and improved inverted flight performance. In addition, the chord of these contest class rotor blades have been optimized for improved autorotations while maintaining crisp cyclic responses, unlike other 'wide chord' rotor blades which tend to be less definitive in response. Moreover, a specially selected low drag airfoil has been used which provides extremely smooth and fast forward flight characteristics. The performance of the new GMP rotor blades is described by many top pilots as awesome!

## NEW FIBERGLASS (FRP) ROTOR BLADES

The custom rotor blades provided in most kits feature an advanced semi-symmetrical airfoil for the best all-around performance. Hovering characteristics are excellent with superb stability while 'peppy' aerobatic capabilities are maintained. Also, due to the high lift airfoil, autorotations are phenomenal! For the helicopter connoisseur who prefers 'glass' blades, GMP is proud to be the exclusive USA distributor of "LM" fiberglass rotor blades designed by Len Mount, several times British Nationals Champion. These blades come factory finished ready to install on your Competitor, King Cobra, or Legend, and feature a high-lift reflex airfoil and a unique drag reducing tip design. Performance is smooth, aerobatic, and powerful!

For the future, GMP continues to work on blade design and soon expects to produce a new very radical rotor blade design for model helicopters. These blades incorporate the results of the very latest full sized helicopter research and development and will be another exclusive first for the RC model helicopter industry.

- (The lengths provided after the blade description indicates the distance from blade tip to bolt hole to assist you in selecting the proper blade for other brands of RC helicopters.)

### For Cricket/Hughes 300C

PART #190 Custom Main Rotor Blades (15.5 in., 39.25 cm.)

PART #191 Tail Rotor Blades

PART #191H Tail Rotor Blades Hughes

### For Rebel

PART #550R Custom Main Blades (18 in., 45.7 cm.)

PART #9551 Tail Rotor Blades

### For Cobra and Jet Ranger

PART #550S Custom Main Blades (20.4 in., 53 cm.)

PART #551 Tail Rotor Blades - Wood

PART #9551 Tail Rotor Blades - Nylon

### For Legend, King Cobra, Competitor

PART #9550 Custom Main Blades (24.15 in., 61.5 cm.)

PART #551 Tail Rotor Blades - Wood

PART #9551 Tail Rotor Blades - Nylon

### For Legend, King Cobra, Competitor, w/extended Tail Boom

PART #9550L Custom Main Blades (25.4 in., 64.5 cm.)

PART #9550LS Contest Special Main Blades (25.4 in., 64.5cm.)

PART # 9550FGL Fiberglass Main Blades (25.25 in., 64 cm.)

### For Stork SE

PART #950 Rotor Blade Main (26 7/8", 68.3 cm.)



# GMP TOOLS & TOOL KIT

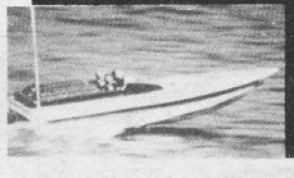
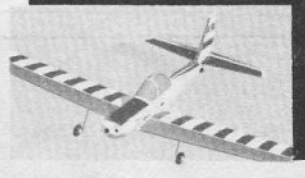

#635



## TOOL KIT CONTAINS:

- Ball Link Pliers
- Phillip Head Screwdriver
- Slotted Head Screwdriver
- 1.5mm Hex Head Screwdriver
- 2.5 mm Hex Head Screwdriver
- 4mm Nut Driver
- 5.5mm Nut Driver
- Long Nose Pliers
- GMP Pitch Gauge
- Bottle(Thred Locking Agent)
- (4) Bondhuss Hex Keys

NOTE: All Drivers made of Chrome Vanadium Steel

#688



#640



#639



#684



#636



#638

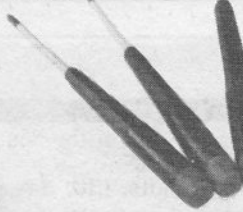

#683

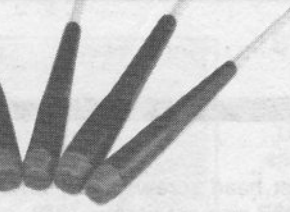

- PART #635 Helicopter Tool Kit
- PART #692 Pitch Gauge - scale
- PART #637 Hexdriver - 1.5mm
- PART #638 Hexdriver - 2.5mm
- PART #639 Nutdriver - 4mm
- PART #640 Nutdriver - 5.5 mm
- PART #687 Nutdriver - Large
- PART #688 Ball Link Pliers
- PART #636 Needle Nose Pliers
- PART #683 Flat Head Screwdriver
- PART #684 Phillips Head Screwdriver
- PART #291 Allen Key - 0.05"
- PART #289 Allen Key - 1.5mm
- PART #283 Allen Key - 2.5mm
- PART #282 Allen Key - 2mm
- PART #290 Allen Key - 3mm
- PART #289B Allen Key - Long - 1.5mm
- PART #283B Allen Key - Long - 2.5mm
- PART #282B Allen Key - Long - 2mm
- PART #290B Allen Key - Long - 3mm
- PART #286B Allen Key Set - Long includes 1.5, 2.5, 2, and 3mm long Allen Keys
- PART #286S Allen Key Set includes 1.5, 2.5, 2, and 3mm Allen Keys

- #290B
- #283B
- #282B
- #289B

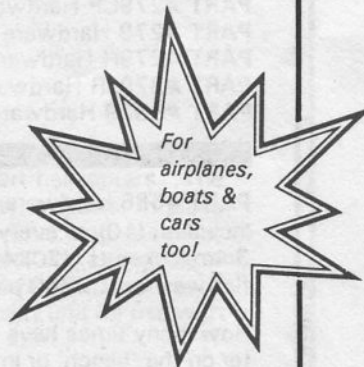

GMP has a fine line of all tools necessary to construct and maintain your R/C helicopter. These top quality tools include hardened steel allen keys, chrome vanadium steel nut and ball drivers, ball link pliers and much more. They can be purchased separately or in the new budget priced **GMP Tool Kit**. This kit contains contains all tools needed to built and maintain an R/C helicopter. Its unique design is compact and convenient, making it perfect for construction, repair, or those special adjustments when you are in the field. The kit comes fitted into its own leatherette zip-up case and retails for half the price of comparable tool kits. Not only is it a must for every helicopter pilot, but it is excellent for use with R/C cars, boats, and airplanes.

# GMP METRIC HARDWARE SETS

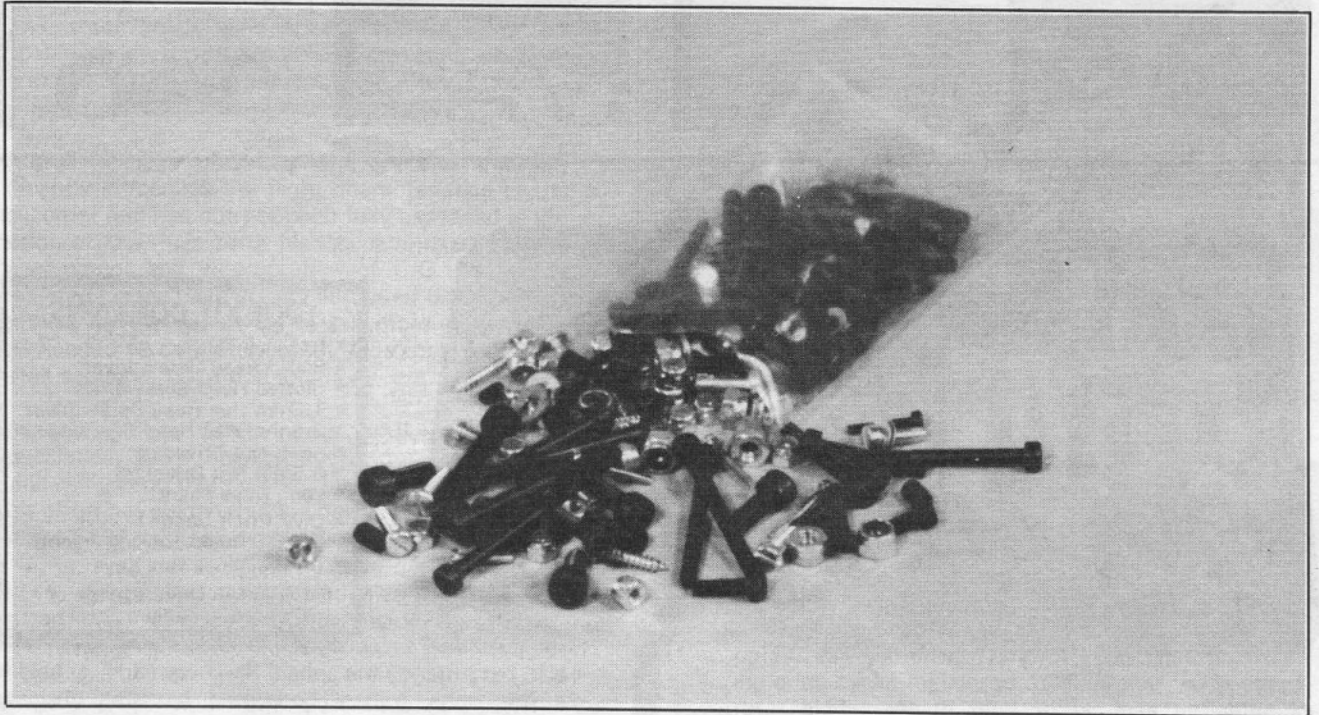

- PART #879 Hardware Set - Cobra
- PART #279CP Hardware Set - Competitor
- PART #279 Hardware Set - Cricket/Hughes
- PART #279H Hardware Set - Extra - Hughes
- PART #879JR Hardware Set - Jet Ranger
- PART #9579 Hardware Set - Legend

**PART #686 Hardware Set - Super Metric - For All Helis**

Includes (10) of every GMP size pan head and socket head screws, (20) 2mm plain nuts, (30) 3mm plain nuts and 3mm lock nuts, (20) 4mm lock nuts, (10) of every GMP size set screw, (20) 2mm and 3mm flat washers, (10) 4mm flat washers.....340 pieces in all!

How many times have you been frustrated by not having extra nuts, bolts and washers when working on your helicopter on the 'bench' or in the field? GMP offers a complete line of metric hardware available individually or in our budget priced hardware sets suitable for your Cricket, Cobra, King Cobra, Competitor or Legend. These hardware sets include all of the nuts, bolts, washers, and screws included in your original kit in one convenient package. Don't be delayed again.....get your hardware set today!

SOCKET HEAD SCREW

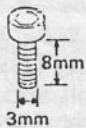

PAN HEAD MACHINE SCREW

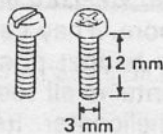

TAPPING SCREW (P.K.)



SET SCREW

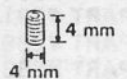

LOCKNUT



WASHER



NUT



# SET-UP AND FIELD ACCESSORIES

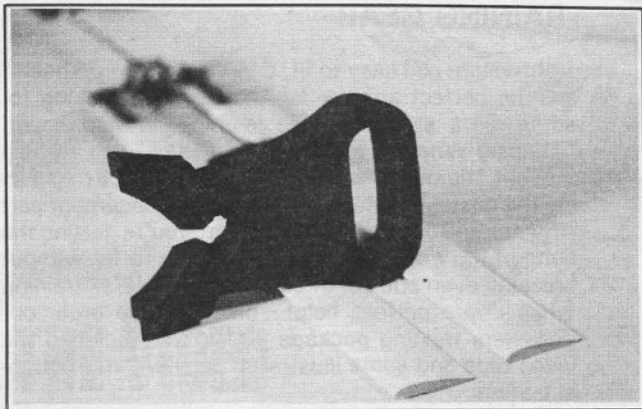

## BLADE STAND

FITS ALL TYPES (SCALE, POD AND BOOM)

Don't damage your rotor blades and linkage when you transport your RC helicopter. Fold your rotor blades back and use a GMP rotor blade holder. Made of PVC foam, it is shock absorbent, flexible, and light weight. Low in cost, it makes transporting your helicopter so much safer and easier.

PART #632 Blade Stand

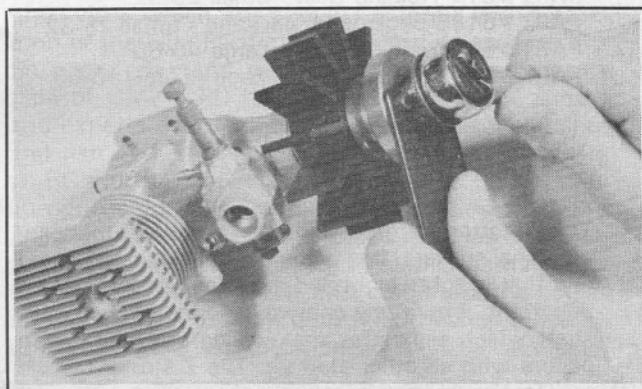

## FLYWHEEL TOOL

Have you ever had difficulty (maybe even broken a fan) when trying to tighten the engine nut to secure the flywheel/fan assembly because you couldn't get a firm grip? GMP's new flywheel tool eliminates this problem for good. Made of high strength steel, this unit bolts to the flywheel of any GMP helicopter and allows you to easily and safely tighten the engine nut. Can also be used with most other manufactures 50-60 size helicopters.

PART #691 Flywheel Tool

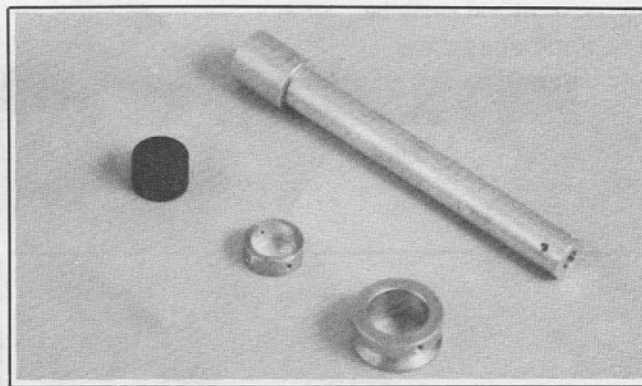

## STARTER EXTENSIONS

Two different starter adapters are manufactured by GMP for use on any/all cone start helicopters. The adapters fit onto the 'Sullivan' type starter in place of the one which comes with it. The 'long' starter is for Competitor, Cobra, King Cobra, and Legend, and the 'short' one for Cricket and Rebel. The 'short' adaptor can also be fitted with pulley unit for use with boats or helis which have a belt start.

PART #621L Starter Extension - Long

PART #621LP Starter Extension - Short



## NI-STARTER

GMP carries the McDaniel line of "Ni-starters" to ease the starting process of your helicopter. With the portable, nicad battery powered starter, you no longer have to worry about having your helicopter directly next to the flight box so the glow driver cord will reach. Also, with its small size and unique 'plug-lock' system, the ni-starter is a breeze to attach to your helicopter's glow plug. Comes complete with charger.

PART #620 Ni-Starter

# SET-UP AND FIELD ACCESSORIES



## TRAINING GEAR

Lightweight and easy to fit, GMP's "Training Wheels" are the perfect answer for the beginner looking for some extra stability while learning how to hover. "Training Wheels" extend your landing gear to help prevent "tip-overs" in the early stages, thus minimizing the mistakes which can result in replacement part expense and down-time just when "you're getting the hang of it". Yes, it is possible to learn to fly without breaking even one set of blades, and GMP's "training wheels" are perfect help! You may also order our beginners training package which also includes the video tape and some illustrated beginners instructional leaflets.

**PART #614 Training Gear - Small 25-32**

**PART #614S Beginner's package - Small 25-32**

**PART #615 Training Gear - Large 40-60**

**PART #615S Beginner's package - Large 40-60**

## Z-STARTER

The Z-starter is a great improvement over other conventional starters. It is a compact and self-contained unit that is lightweight and easy to maneuver. Most important, it utilizes a one-way bearing on its output shaft which eliminates that vexing grabbing which occurs with all other starters. The Z-starter can be used for both belt and cone starts (on cars, planes, or helicopters). It's the hi-tech answer for more convenient and smoother starts.

**PART #689 Z-Starter**

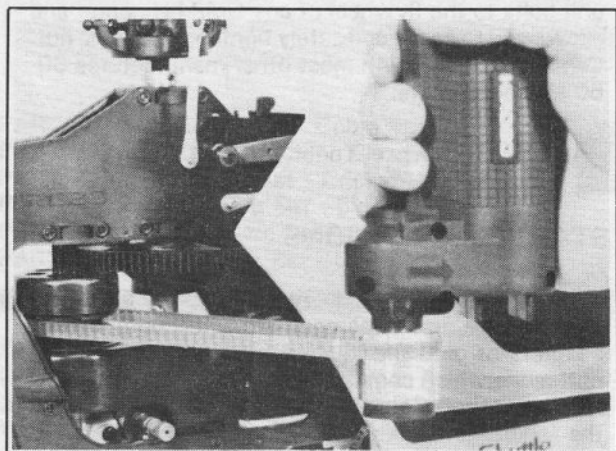

## GMP RATE GYRO

The installation of a gyro on your helicopter is greatly recommended for added stability. GMP's Semi-Automatic Gyro (also known as GMP's Rate Gyro) is great for the beginner because it automatically trims down unwanted activity in your helicopter while permitting your radio commands to be obeyed without resistance. It is the least expensive and most popular gyro available in the USA. So for quick learning and improved flying, order your GMP gyro today!

**PART # 671K GMP "Automatic" Rate Gyro**

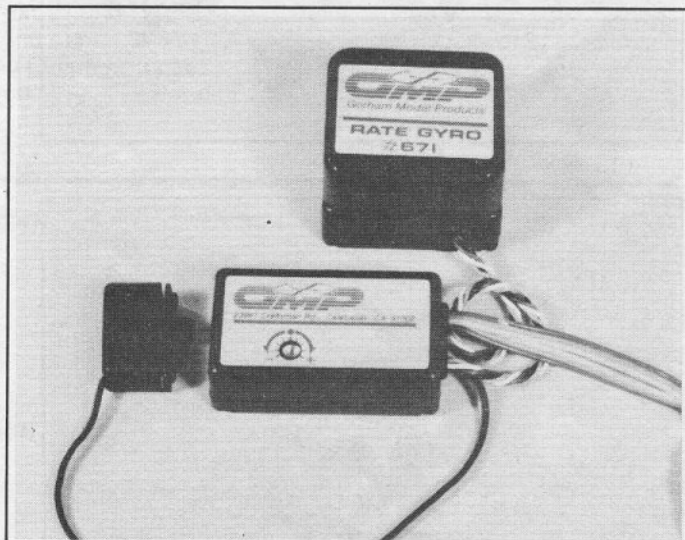

# SET-UP AND FIELD ACCESSORIES

## RC Helicopter Flying .....

### THE VIDEO

Learn to hover and watch the experts fly - all in one great video which was shot in California with a backdrop of the blue Pacific and California beaches. Sit back, relax and watch this 23 minute cassette tape of GMP's RC helicopters flown by beginners and experts over land and sea. Professionally shot and narrated, it brings to life the flying maneuvers an RC modeler especially wants to see. It not only introduces you to the amazing aerobatics of GMP's fine line of helicopters, but it also includes a section which guides the novice step by step in learning how to hover. This is valuable information for the beginner who wants to learn quickly and safely but who does not have an experienced teacher available.



GMP's new video also includes incredible footage of the flying abilities (autorotations, inverted flights, loops and rolls, etc.) of Gorham Model Products entry level up to the competition class models and fliers - PLUS some flying shots of the 1/5 scale Hind D. Don't miss it!

Includes: Cricket, Cobra, Legend, Rebel, Shuttle, SST Jet Ranger, Competitor, King Cobra

Also available in PALS format

VHS Part# 630  
BETA Part#631



### HELICOPTER HANDBOOKS

GMP stocks many current books on the subject of RC model helicopters. Each one covers the subject a little differently but basically they all describe how a helicopter works, how it is built and how to fly one. If you want a budget guidance course on RC helicopter flying, try the pack of selected RCM columns by John Gorham.

### GMP SHIRTS, HATS, AND JACKETS

GMP shirts are available in blue or white cotton/polyester blend and come in sizes small, medium, large, X large, and XX large. GMP hats are available in blue and one size fits all. Jackets are blue in color and come in all sizes. They are of very high quality and look great!

PART #613 GMP Hat  
PART #681S Shirt - Blue - Small  
PART #681M Shirt - Blue - Medium  
PART #681L Shirt - Blue - Large  
PART #681XL Shirt - Blue - X Large  
PART #681XXL Shirt - Blue - XX Large  
PART #680S Shirt - White - Small  
PART #680M Shirt - White - Medium  
PART #680L Shirt - White - Large  
PART #680XL Shirt - White - X Large  
PART #680XXL Shirt - White - XX Large  
PART #682S Jacket - Small  
PART #682M Jacket - Medium  
PART #682L Jacket - Large  
PART #682XL Jacket - X Large

PART #605 Book by Day  
PART #604 Book by Don Lodge  
PART #607 Reprints of John Gorham's RCM Articles

# SET-UP & FIELD ACCESSORIES

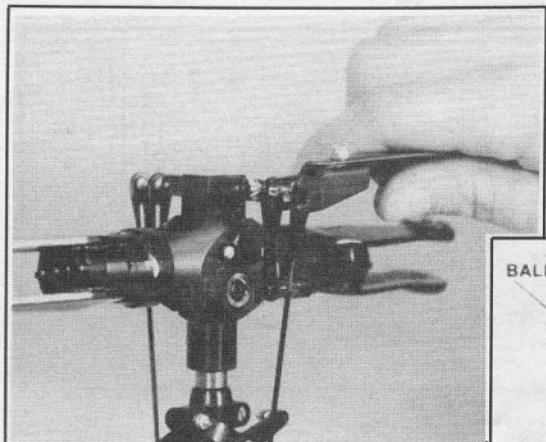

## BALL LINK PLIERS

GMP's ball link pliers helps the RC enthusiast build and maintain his model helicopter with greater ease. Right-side-up, the GMP plier is a handy tool which will help you to quickly remove all of your ball-links. Flipped over, you can refit the ball links just as easily. A great work and fingernail saving device.

PART #688 Ball Link Pliers

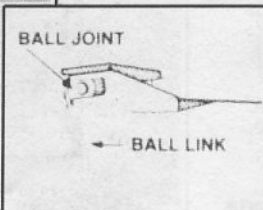

## GMP PITCH GAUGE

Designed and manufactured to be a fine precision measuring tool, the GMP Rotor Pitch Gauge allows precise measurement of collective roll and pitch adjustments. One super feature of this gauge is that it can be used without the necessity of leveling your helicopter. So "fine tune" your helicopter with a GMP Rotor Pitch Gauge and let your helicopter perform to its aerobatic limits!

PART #672 Pitch Gauge

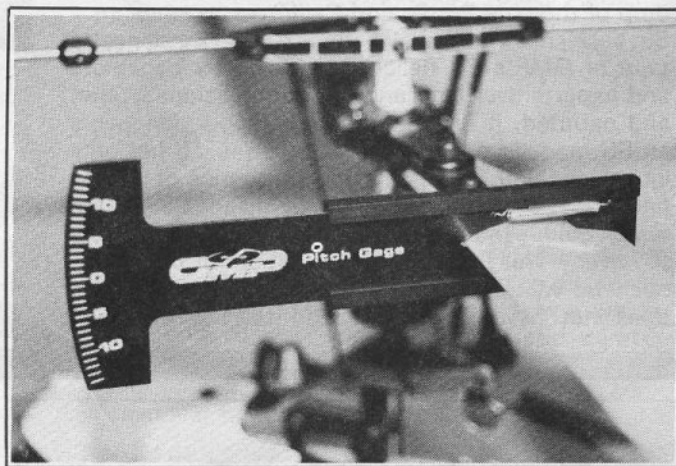

## WHIP ANTENNA

Gone forever is the nightmare every heli-flier dreads...stepping on a 3-foot antenna and ripping it off the front of your prized chopper just as it's ready to fly. Base loaded, this short whip antenna gives "hidden performance". Less than 7" long, it can be mounted to project in front of your helicopter or lie inside the canopy where it is virtually invisible (but still effective).

PART #673 Whip Antenna

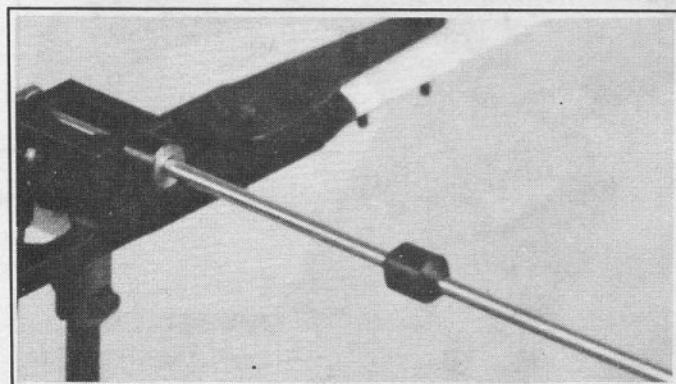
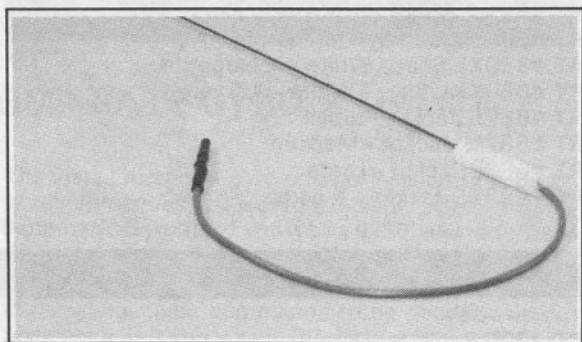

## FLYBAR WEIGHTS

GMP flybar weights are excellent for 'fine-tuning' the set-up of your helicopter by eliminating vibration caused by a flybar imbalance. They also add additional weight to the flybar which adds stability to the helicopter. GMP flybar weights are secured by set screws so they are easily adjustable. A must for any R/C helicopter pilot!

PART# 670CP Flybar Weights - for Cobra, Competitor, Legend and Rebel

PART #670 Flybar Weights for Cricket

# TAIL ROTOR DRIVES

## GEARS OR BELTS?

The tail rotor drive on our RC helicopters is a very important part of the whole system. Tail control is notably "skittish" - and many pilots use a gyro to help reduce the unwanted activity "back there".

However, an accurate and "slop" free system is needed to enable the flier to have precise control when needed for the advanced rotational maneuvers which are one of the most colorful and inspiring differences between the flight of a 'mere' aeroplane and a helicopter.

Advanced helicopter fliers can perform 4 point pirouettes in the hover or even while flying in fast forward flight (see our video). Because of the importance and dependency on good tail rotor control, GMP insists that the very finest design and construction is employed in their tail rotor systems.

The standard tail rotor drive gearing on the "front end" of Cobras and Competitors uses very advanced design spiral hypoid gears - a quiet and efficient method unique to our machines. Compare with the straight spur gear system of other makes.

The rear drive uses a very light but beautifully made all-metal gearbox which provides low friction but very precise control also using dual spiral hypoid gears. This gearbox (shown in the photo) is standard on the

GMP Cricket, Cobra, Rebel and Legend (tail gearbox versions).

In late 1986 the belt drive system was reintroduced to the world. A belt drive was used on early RC helicopters - but with a big difference - the belt was smooth and frequently slipped. Using modern technology to the full, our new tail drive system uses a hitech composite toothed belt drive developed and used by many industries today as a light and reliable method to transmit rotary motion.

The first use of this dramatically new system was on the Shuttle. It was very successful and flyers soon appreciated the tighter tail control (and hence more accurate maneuvers) which the use of this drive gave to their helicopters.

The GMP Legend 'Elite' addition also uses the toothed belt drive on a .60 size machine with the same result - reliability and tighter control.

Controversy will continue on which drive is superior but one thing is sure - the toothed tail belt drive is here to stay. Our latest tail belt drive "rear end" is shown in the photo on this page. Our new helicopters are designed so that you may have the choice of either gear or belt drive systems without modification to your helicopter - YOU DECIDE.

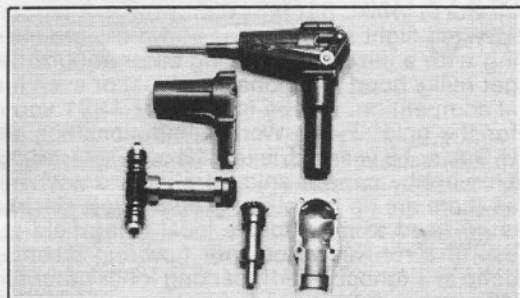
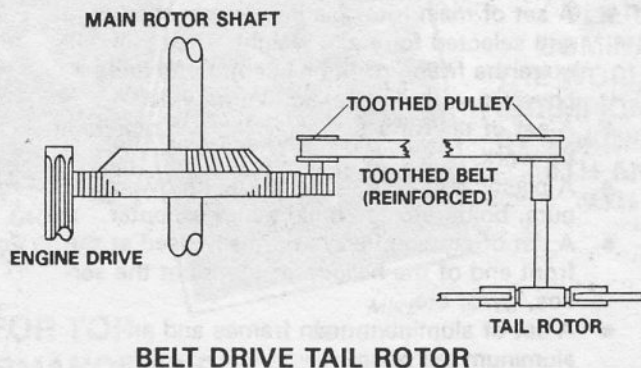
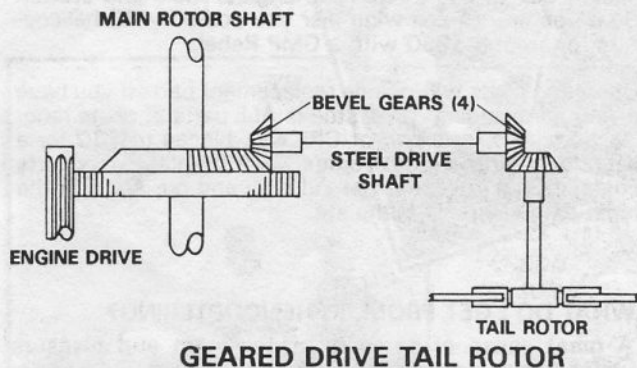

GMP's Tail rotor gearbox unit.

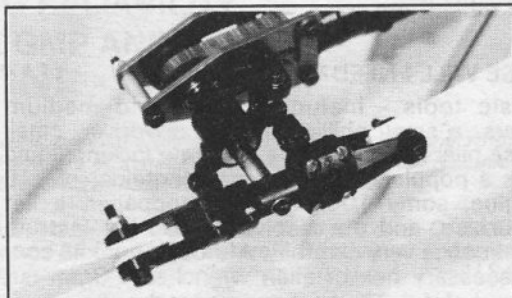

GMP's Belt drive tail rotor unit.

# IS IT FOR ME?

Now that you have seen what we have to offer in the field of RC model helicopters we may have inspired you to find out more about this branch of model aeronautics. So we will pose some typical questions and try to provide some realistic answers for you.

## DO I HAVE TO BE A MECHANICAL GENIUS?

No, of course not; all the machining and some of the assembly has been done for you - at least in GMP kits it has.

However, you should at least have an appreciation for the need to be reasonably precise and careful in your assembly and adjustments. If you do not have this "feel" for mechanisms and the care that they need, you may not be as successful as you would wish in your efforts. You may even find that trying to fly RC helicopters without this care and attention could result in possible hazard to you or those close to you when you fly.

Having stated the above, we'll assume that you have a positive attitude and enough knowledge and still want to proceed. So the next question could be:

## WHAT DO I GET IF I BUY A HELICOPTER KIT?

Here's what you get in any GMP kit:

- A very complete and well illustrated building and flying instruction manual.
- A set of about ten plastic bags, each containing the parts needed to completely assemble one sub-assembly of your new helicopter. Detailed instructions to build each sub-assembly are contained in the building instruction manual.
- A set of main rotor blades already sanded and selected for equal weight. They will require the fitting of the blade mounts and covering with the plastic film provided.
- A set of tail rotor blades which will require little work.
- A plastic bag containing all the hardware, nuts, bolts, etc., to build your helicopter.
- A set of plywood parts normally used at the front end of the helicopter to mount the servos, gyro, etc.
- A set of aluminum main frames and an aluminum tail boom.
- Several sundry parts such as piano wire, plastic tubing, etc.

## WHAT ELSE WILL I NEED?

Some basic tools - including small and medium screwdrivers, a small phillips head screwdriver, small needle nose pliers, a small tube of screw locking liquid, Loctite is a popular brand, a small container of "10 second" glue, some 100/150 grit sandpaper, a flat working surface, and the resolve to read the instructions at least once very carefully. Although our kits contain the necessary hex or allen wrenches, a 3mm nut driver is very helpful. The best source for the above supplies is your local hobby store; but your local radio, automotive or hardware store would be good places to

try also. The new GMP Tool kit contains Loctite and most of the small tools you will need.

You will need a radio control system, a suitable engine and muffler and an electric starter. Ideally again, seek the advice of your local hobby store personnel. If they are not too experienced in RC helicopters, check with GMP's technical service and they will advise you. Please make sure that you buy a suitable, good quality radio and engine. Both these items are obtainable in special helicopter versions at reasonable prices and it will make the building and learning tasks so much easier for you.

## HOW MUCH WILL IT COST?

Of course your initial cost will depend upon two factors; whether you are already an RC modeler and what class of RC helicopter you will decide upon. Here is at least a guide to give you some idea. RC helicopter kits cost from around \$200 to \$350 for the smaller models such as **CRICKET**, \$350 to \$500 for the larger more sophisticated models like the **COBRA** range and, between \$600 to \$750 for top quality contest winning helicopters like **LEGEND** with the **ELITE** rotor head.

Suitable radio equipment will cost around \$250 for a simple system and \$1000 for a top-line computerized competition system. An engine will cost between \$75 to \$200. A gyro is also desirable item - add about \$75. The new entrant into RC modeling would pay \$600 to \$1500 and up if he has to buy everything.

Because of the relatively high entry costs which may discourage many budding heli fliers GMP has produced for 1990 the '40' powered '**REBEL**'. Rebel has been designed specifically to use an airplane engine, radio and starter. So if you are a fixed wing flier you could fly RC helicopters for around \$250 with a GMP Rebel.

Operating costs will include replacement parts if you have a very hard landing! GMP stocks **ALL** parts at costs ranging from \$10 for a pair of **CRICKET** blades to \$30 for a set of two **COBRA** main frames. GMP's replacement parts costs are the lowest in the industry and our stock is the most extensive and complete.

## WHAT DO I GET FROM RC HELICOPTERING?

A great sense of personal achievement and pleasure which has to be experienced to be believed. Even to accomplish a steady hover for 10 seconds could make it all worth while. But how about the excitement of doing inverted flight a few inches above the ground? Or landing with a dead engine using autorotation? Then if you get really good - regional, national or even International competition. Maybe in 1989 or 1991 you could "go for the gold" in the World Championships just like the U.S.A's 18 year old Texan did so successfully in 1987. This hobby can be enjoyed almost anywhere (as long as there are no people or property too close) and there is no need to drive to the local flying field to have the use of a runway since your hovering practices can be done in a (unoccupied!) parking lot or other flat surface. Why not at least send for our new video - it will really show you how you may enjoy becoming part of "our wonderful world of RC helicopters"



# GMP DOES IT AGAIN!

## GMP Fliers Sweep the 1989 US Nationals

### CONTEST RESULTS

#### F.A.I. -

1st **CURTIS YOUNGBLOOD**  
GMP Competitor/Elite  
3rd **ROBERT GORHAM**  
GMP Legend/Elite

#### INTERMEDIATE -

1st **JOHN THOMAS**  
GMP Legend

#### NOVICE -

1st **DON NELSON**  
GMP Legend/Elite  
2nd **LAURA SLOCUM**  
GMP Legend  
3rd **MIKE DOUGHTY**  
GMP Cobra

#### SCALE -

1st **SILAS KWOK**  
GMP/Hirobo SST  
Jet Ranger  
2nd **TIMOTHY GARTON**  
GMP/Hirobo Iroquois



Two - time national champions **CURTIS YOUNGBLOOD** & **ROBERT GORHAM** 1st & 3rd in F.A.I. flying the new GMP Elite rotor head with Competitor & Legend mechanics



**JOHN THOMAS**



**DON NELSON**



**LAURA SLOCUM**



**MIKE DOUGHTY**

**GMP FLIERS DOMINATE THE WORLD R/C CHAMPIONSHIPS BY TAKING 3RD, 5TH AND 7TH**



**ROBERT GORHAM**

**FOR TOP PERFORMANCE AND OUTSTANDING RELIABILITY CHOOSE GMP AND WIN!**



**Gorham Model Products, Inc.**  
23961 Craftsman Rd.,  
Calabasas CA 91302  
PHONE: (818) 992-0195  
FAX: (818) 702-0117

GMP's new Elite rotor system is proving itself to be the best performing rotor head in the world. Coupled with GMP's new line of symmetrical rotor blades, this dynamic combination offers unsurpassed flight stability and contest winning performance.

To see the entire range of GMP R/C helicopters in action from .25 cu in **CRICKET**, to the 350 cu in 1/5 scale **HIND 'D'**, send \$25 for GMP's dynamic flight video. Loops, rolls, inverted flight and an easy step by step training seminar. Please specify U.S.A. or PALS format - VHS or BETA.

*"GMP helicopters have dominated the R/C market for the past 10 years by offering fliers competition tested helicopters (and components) which stand up to top national and international competition; and win year after year!"*

## **US NATIONAL CHAMPIONSHIPS**

1989 1st Place .....FAI  
1989 1st Place .....Intermediate  
1989 1st Place .....Novice  
1989 1st Place .....Scale  
1988 1st Place .....Scale  
1987 1st Place .....All Classes  
1986 1st Place .....Expert  
1985 1st Place .....FAI/Expert  
1984 1st Place .....Intermediate  
1983 1st Place .....Expert  
1982 1st Place .....Scale  
1981 1st Place .....Intermediate

1987-1988 1st Place **WORLD R/C HELICOPTER CHAMPIONSHIPS**  
1987 1st Place **CANADIAN NATIONALS**.....Expert  
1987 1st Place **BRITISH NATIONALS**.....FAI  
1989-1990 3rd, 5th, 7th **WORLD R/C HELICOPTER CHAMPIONSHIPS**

*FOR TOP  
PERFORMANCE AND  
OUTSTANDING RELIABILITY  
CHOOSE GMP AND  
WIN!*

Join our growing group of satisfied customers...

As a scale builder, I think that GMP has some of the finest products available today for the sport and serious scale enthusiast.

*Jerry Hicks  
Chesterton, IN  
(Scale builder)*

I would like to compliment you on the Legend. It builds fast and flies great.

*Robert L. Prestridge  
Blythenille, AR  
(Legend)*

Looking at the Legend kit, watching and flying a friend's machine convinces me that the simplicity of design will aid reducing the building time. Also the flight performance envelope was so impressive that this machine will be the one that others will be judged upon.

*Walter Johnson  
Clinton, CT  
(Legend)*

"The quality of the Legend is typical GMP. This is seen during assembly through its smooth flight performance."

*Bob Chatigny  
Weatherford, OK  
(Legend)*

"No other helicopter beats GMP"! Good Job!

*Jeff Johnston  
Canton, OH  
(Legend)*

"Finest kit of any kind that I have ever built"!

*Bob Ditsler  
Danville, PA  
(Rebel)*

I am so happy to report that my pursuit of this Elite head was well worth my time and energy. This head far exceeded my expectations.

*Wayne Sumner  
Charlotte, NC  
(Elite head)*

"After completing my Cobra kit I can see why this model is so popular."

*Bob Chatigny  
Weatherford, OK  
(Cobra)*

"Without question I find GMP products to be exceptional in design, quality and handling. Quite simply you make an excellent helicopter."

*Bill Fike  
Indianapolis, IN  
(Competitor)*



GORHAM MODEL PRODUCTS, INC. 23961 Craftsman Rd, Calabasas, CA 91302

TELEPHONE: (818) 992-0195 FAX: (818) 702-0117