

ERSATZTEILEKATALOG FÜR DIE INNOVATOR HELIKOPTER SERIE

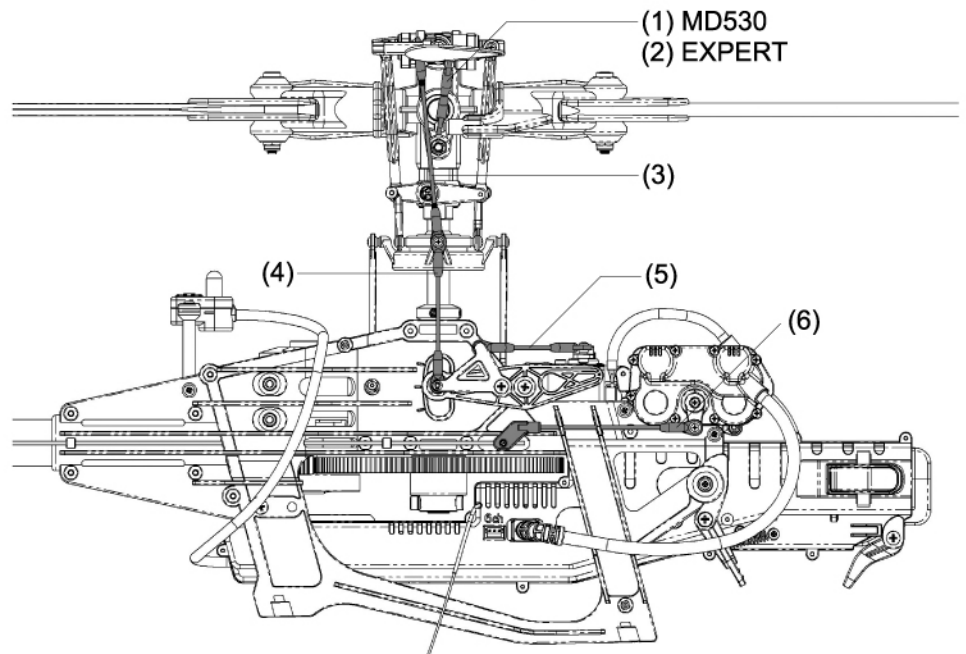

 **Innovator**

SCALE 1:1

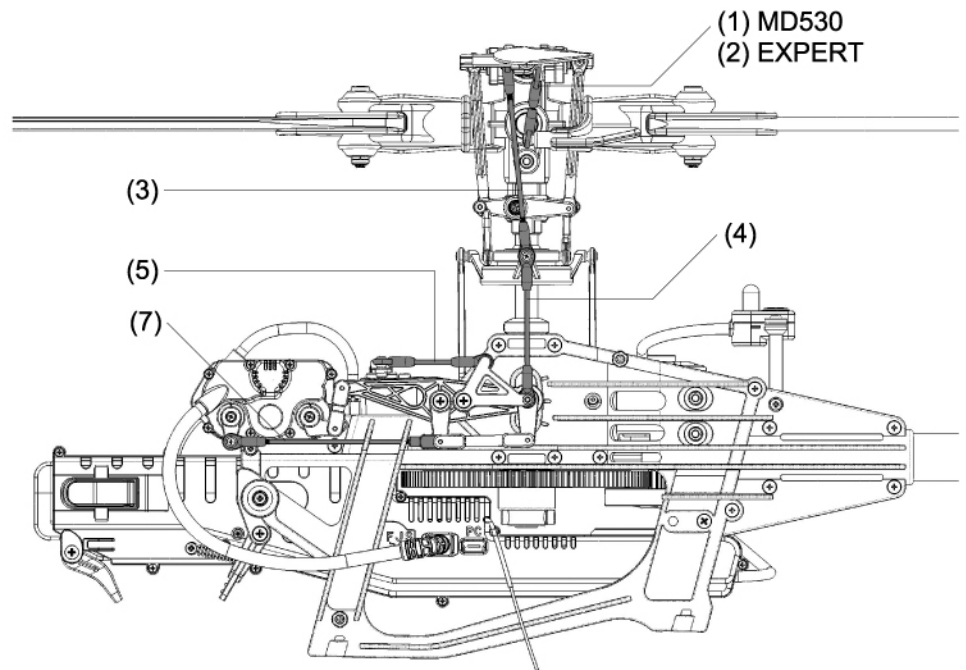
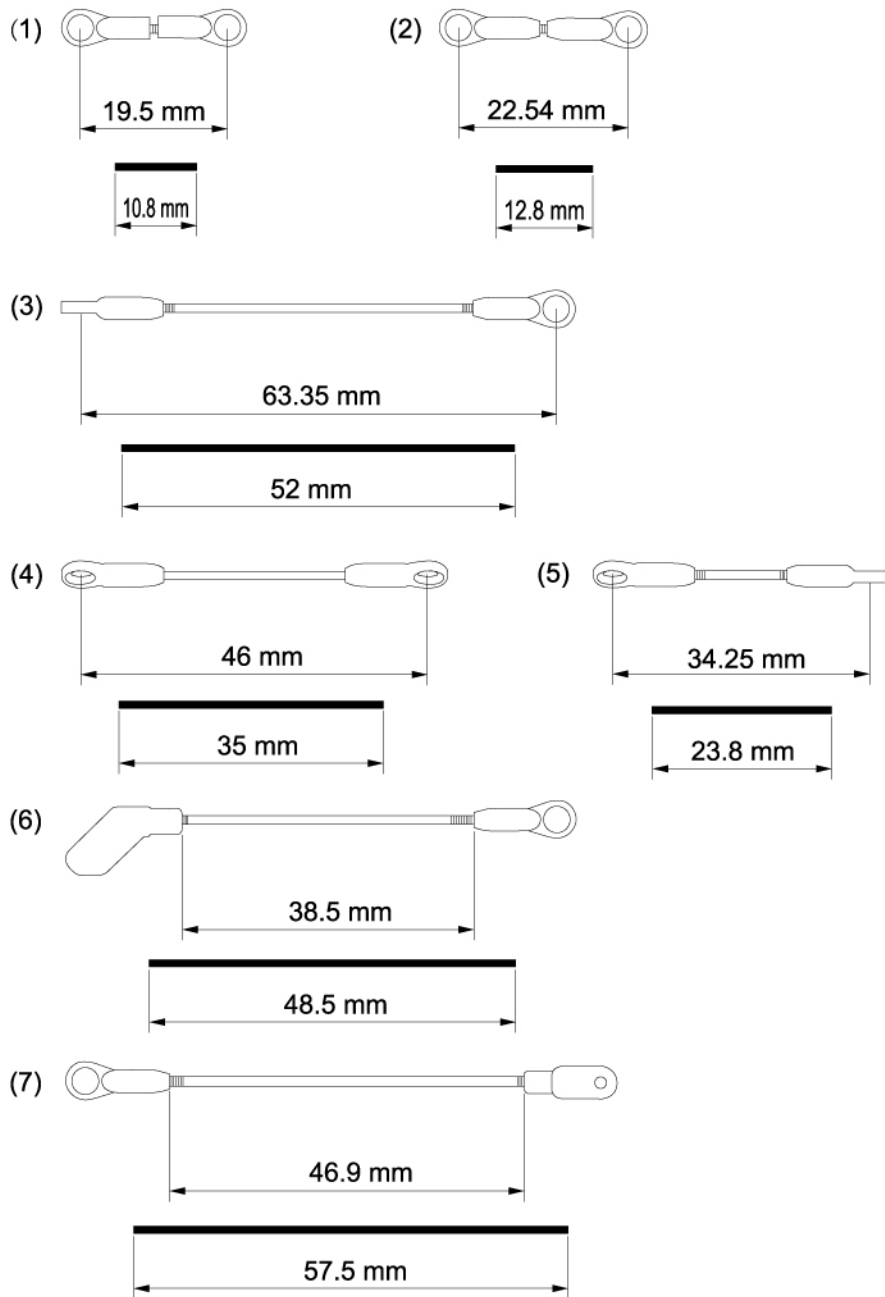

MONTAGE DES ROTORKOPFES

Darstellung Der Montage Der Drucklager

Der Größere Innendurchmesser Muss immer Zum Rotorkopfzentralstück Zeigen
 Der Kleinere Innendurchmesser Zeigt In Richtung Der Rotorblätter

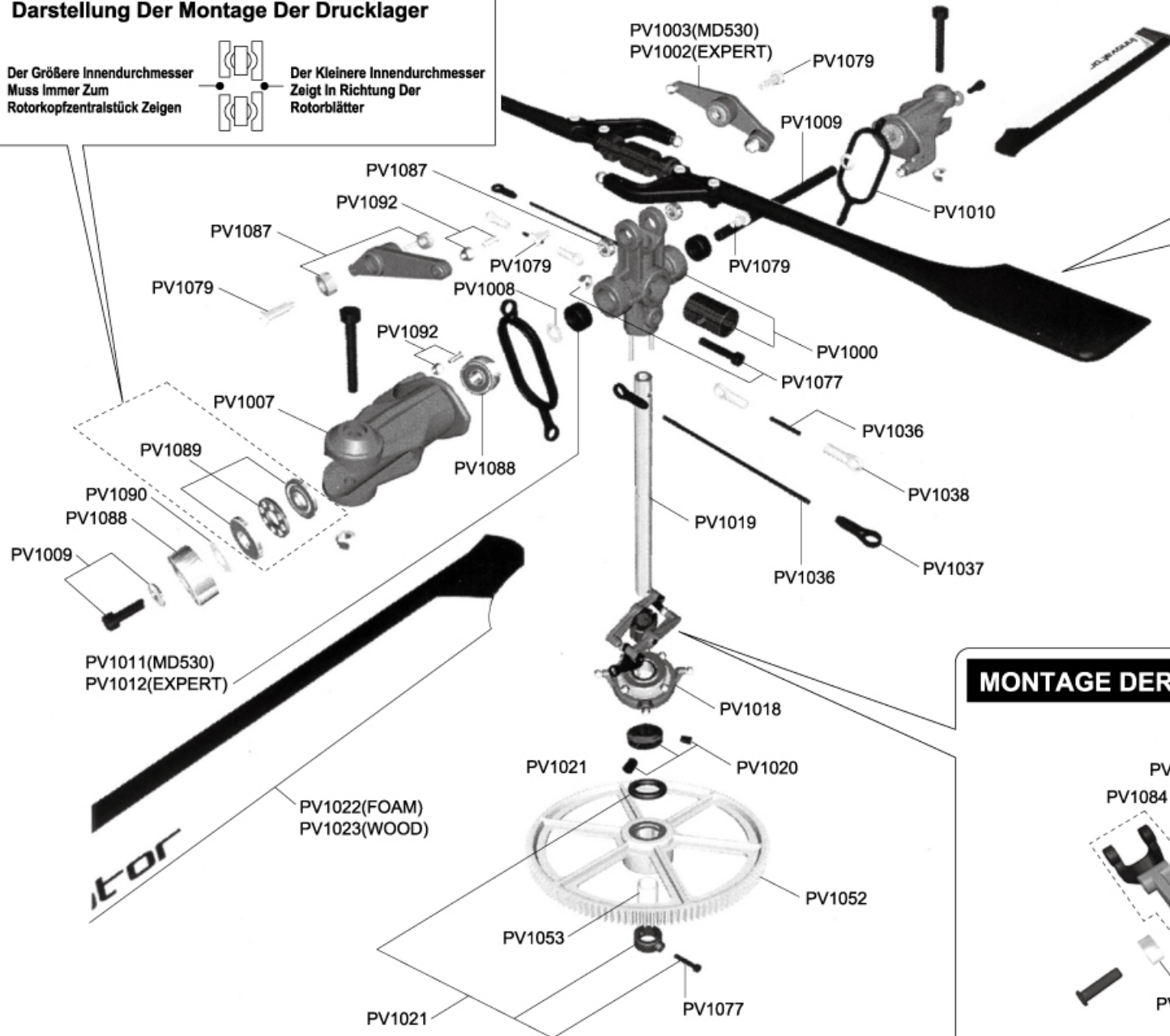

MONTAGE DER PADDEL

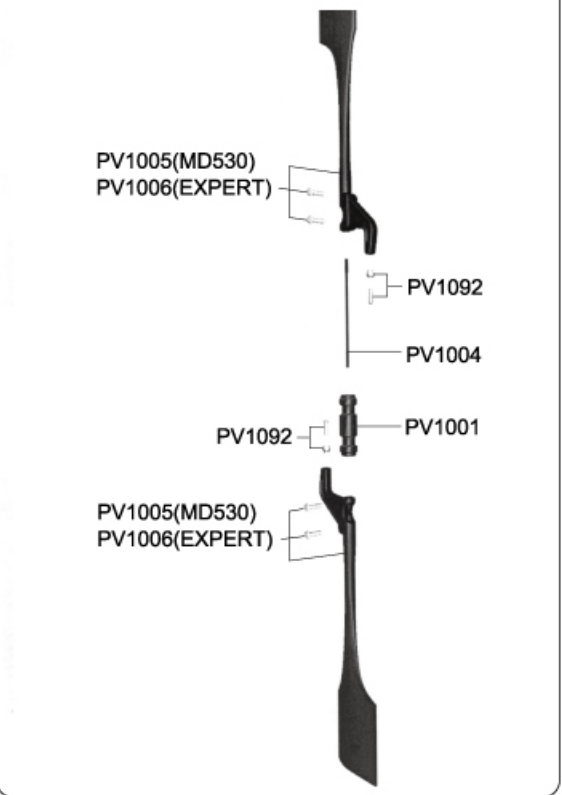

MONTAGE DER TAUMELSCHIBE

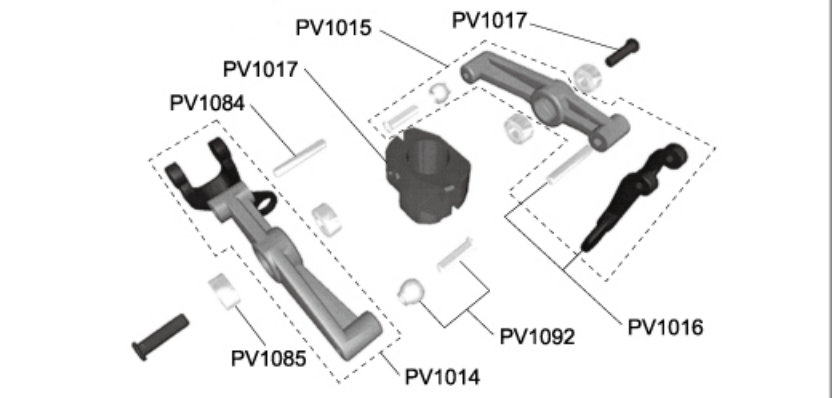

MONTAGE DES CHASSIS

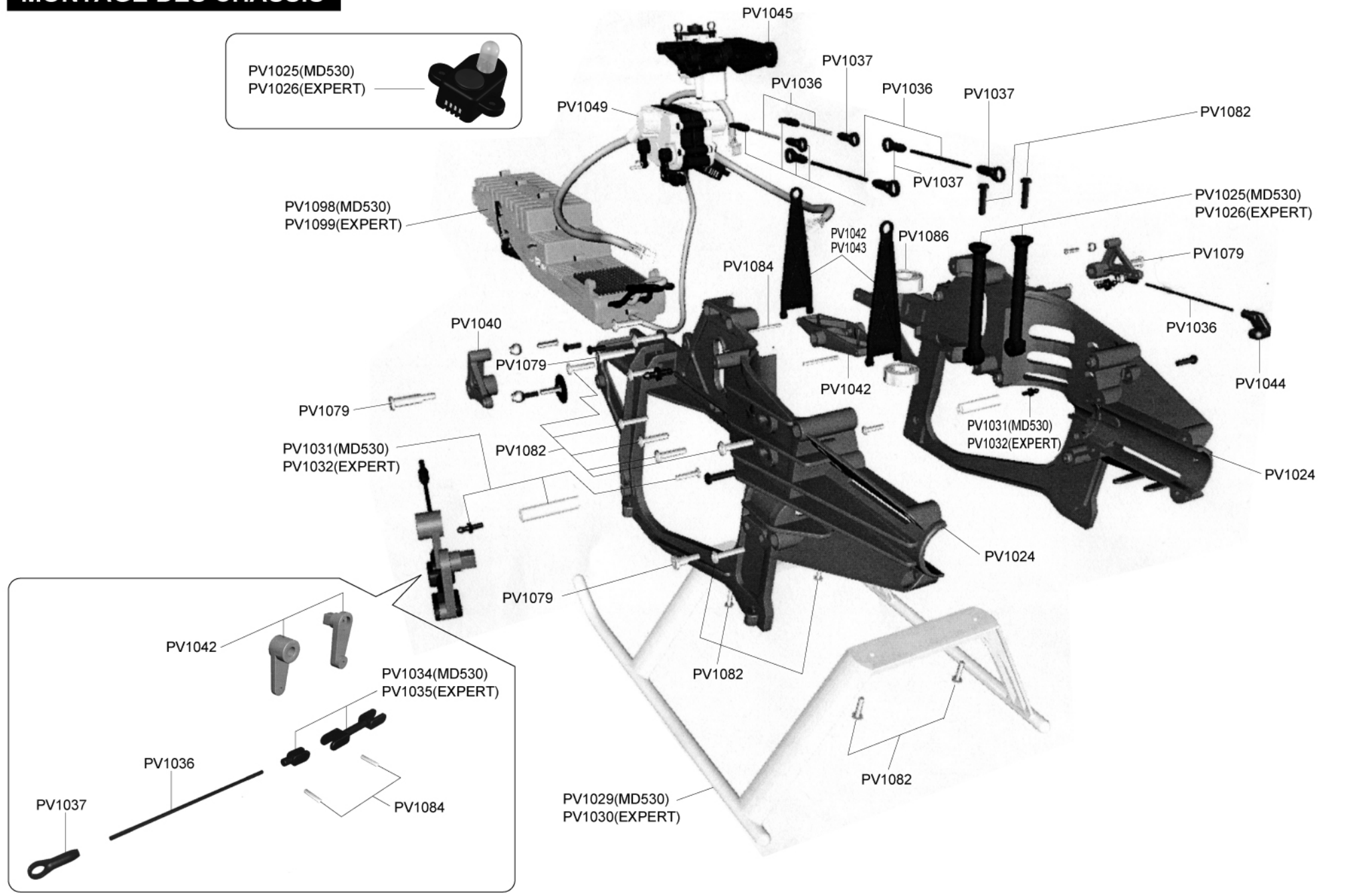

MONTAGE DES HECKS

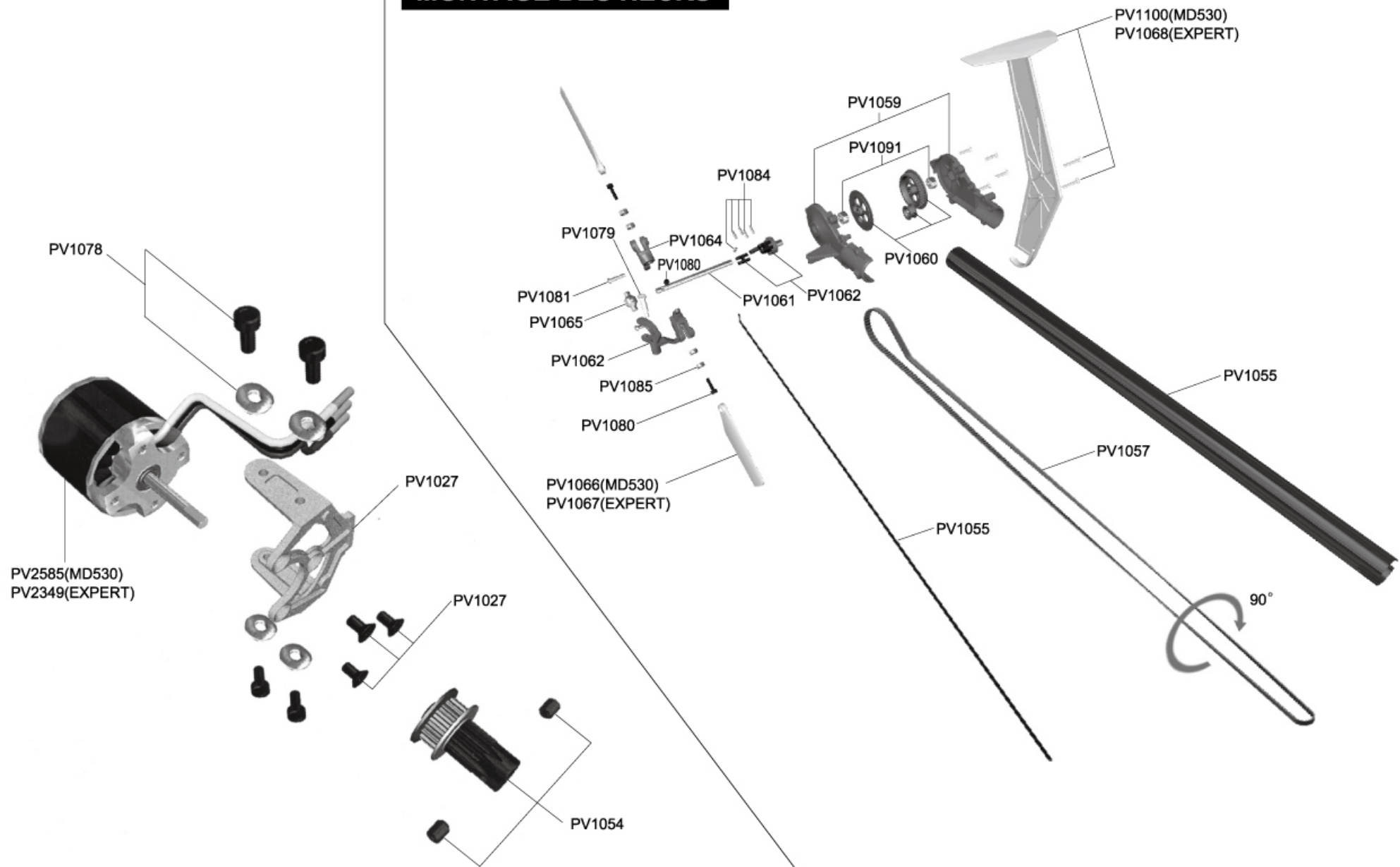

MONTAGE VON MOTOR UND MOTORTRÄGER

3 IN 1 SERVOELEKTRONIK

ROLL SERVO

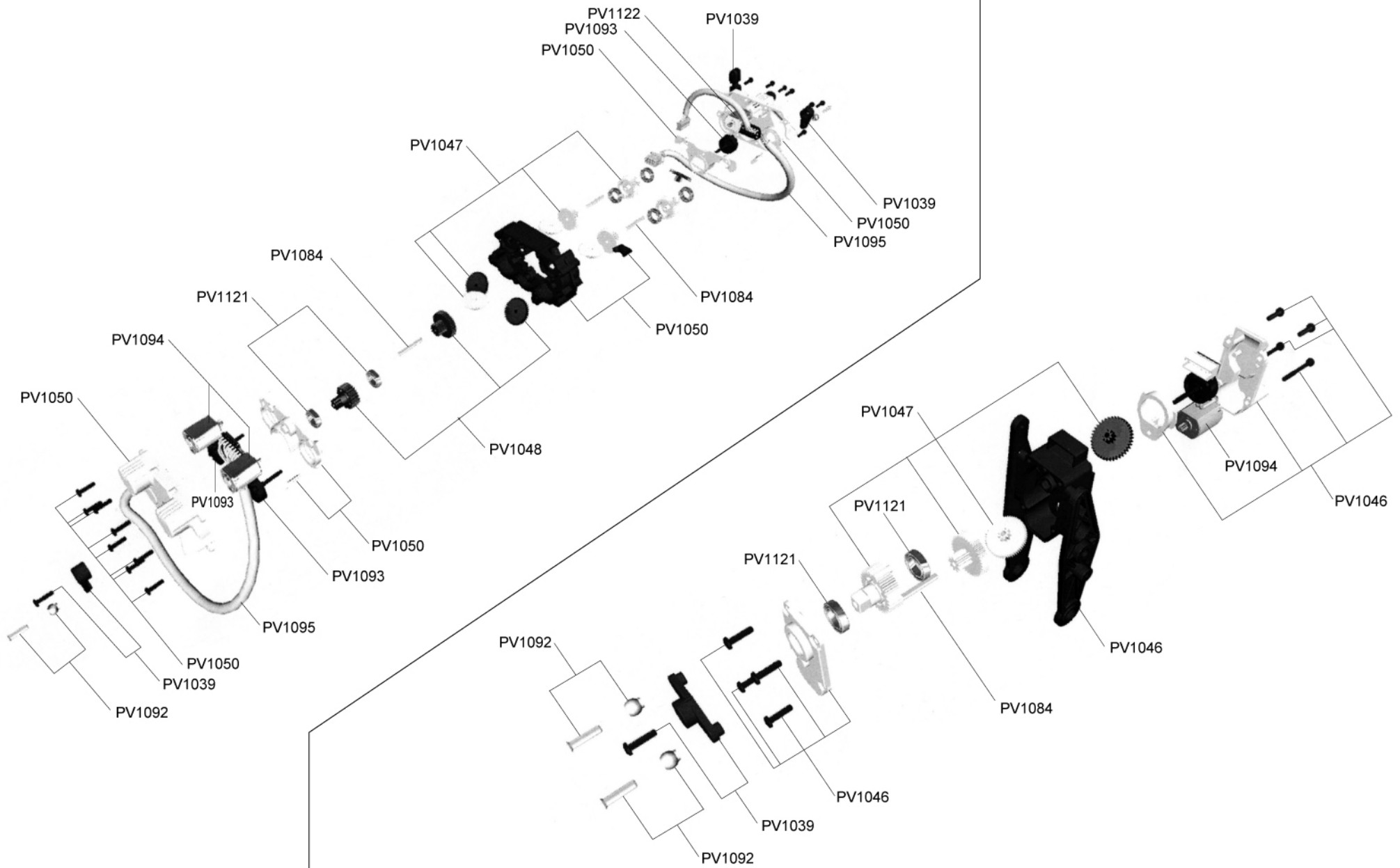

TEILELISTE ABSCHNITT



PV1000 ROTORKOPFZENTRALSTÜCK



PV1001 PADDELWIPPE

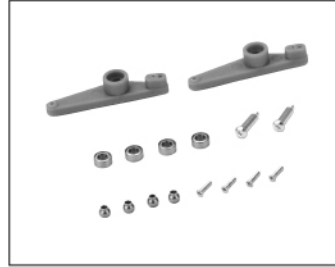

PV1002 MISCHERHEBEL MIT KUGELLAGER

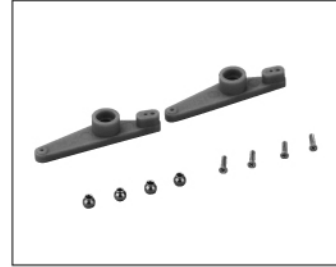

PV1003 MISCHERHEBEL

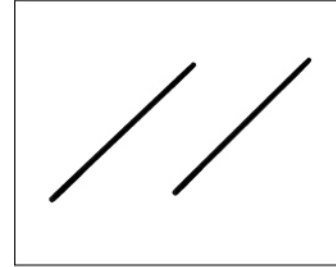

PV1004 PADDELSTANGE



PV1005 PADDEL FÜR MD530

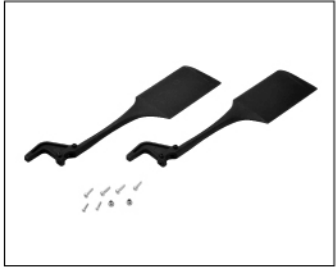

PV1006 PADDEL FÜR INNOVATOR EXP



PV1007 HAUPTROTORBLATTHALTER

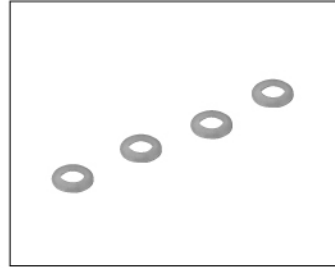

PV1008 SCHLAGSCHEIBEN

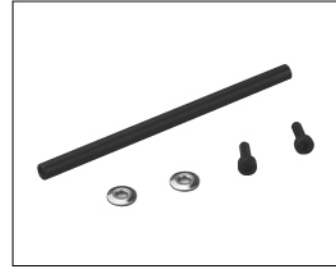

PV1009 BLATTLAGERWELLE

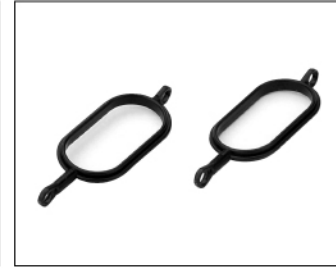

PV1010 PADDELANLENKUNG

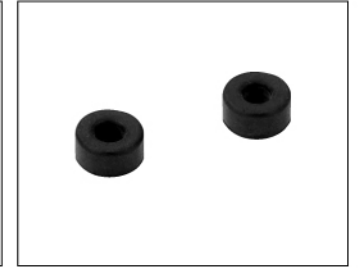

PV1011 DÄMPFERGUMMIS (40B)

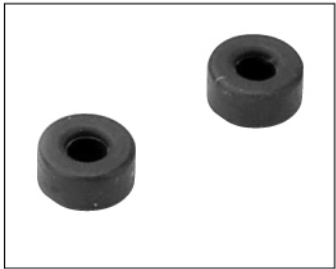

PV1012 DÄMPFERGUMMIS (70L)



PV1014 PITCHKOMPENSATORARME MIT ANLENKUNG

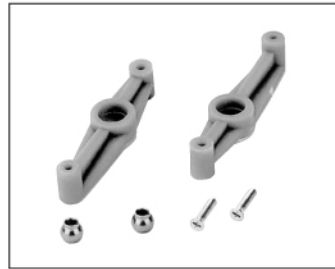

PV1015 PITCHKOMPENSATORARME



PV1016 PITCHKOMPENSATORANLENKUNG



PV1017 PITCHKOMPENSATOR MITTELSTÜCK



PV1018 TAUMELSCHEIBE



PV1019 HAUPTROTORWELLE



PV1020 HAUPTROTORWELLEN ARRETIERUNG



PV1021 RITZELARRETIERUNG



PV1022 SCHAUMSTOFF HAUPTROTORBLÄTTER, 300MM

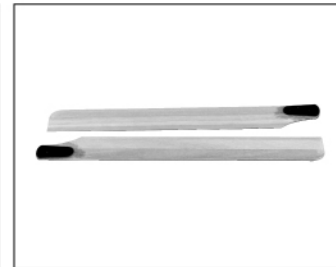

PV1023 HOLZROTORBLÄTTER, 300MM



PV1024 SEITENTEILE CHASSIS

TEILELISTE ABSCHNITT



PV1025 STD SCHALTERHALTER



PV1026 EXP SCHALTERHALTER



PV1027 MOTORTRÄGER

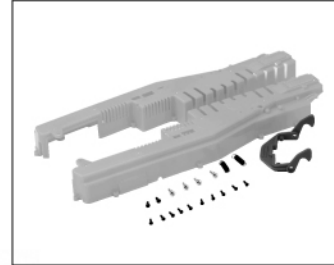

PV1028 ICS GEHÄUSE

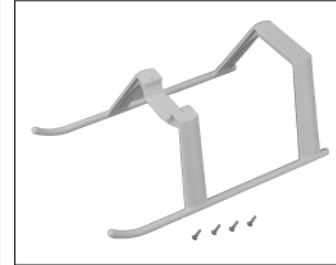

PV1029 MD530 LANDEGESTELL

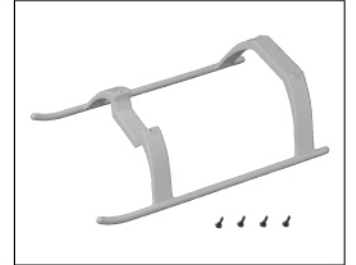

PV1030 EXP LANDEGESTELL

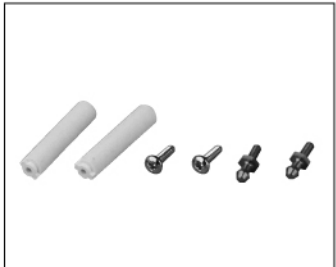

PV1031 STD KABINENHALTER



PV1032 EXP KABINENHALTER



PV1033 HEBEL AKKUGEHÄUSE



PV1034 STD SERVOANLENKUNGEN KPL.



PV1035 EXP SERVOANLENKUNGEN KPL.

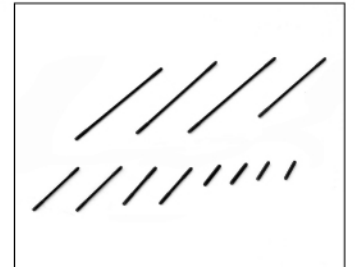

PV1036 SERVOGESTÄNGE

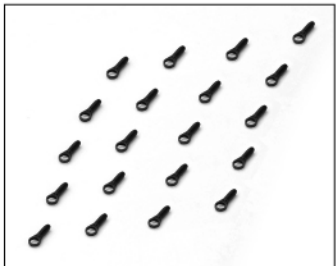

PV1037 KUGELGELENKE LANG

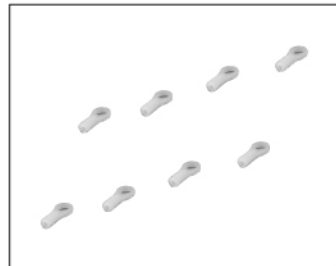

PV1038 KUGELGELENKE KURZ

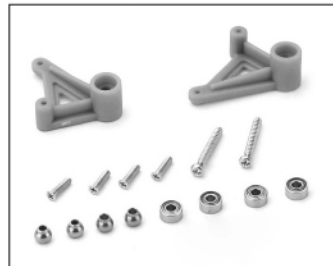

PV1039 SERVOARM SET



PV1040 ROLLARME OHNE KUGELLAGER

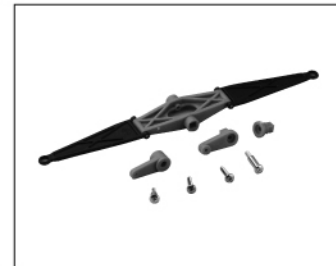

PV1042 NICKWIPPE SET OHNE KUGELLAGER

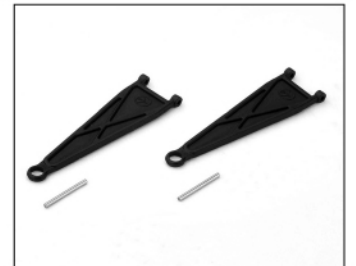

PV1043 NICKARME



PV1044 HECKUMLenkUNG



PV1121 KUGELLAGER(4),D5*D8*W2MM



PV1045 PITCHBRÜCKE MIT SERVOGEHÄUSE



PV1046 PITCHBRÜCKE KIT



PV1047 SERVOGETRIEBE SET



PV1048 HECKSERVOGETRIEBE SET

TEILELISTE ABSCHNITT



PV1049 3 IN 1 SERVOEINHEIT

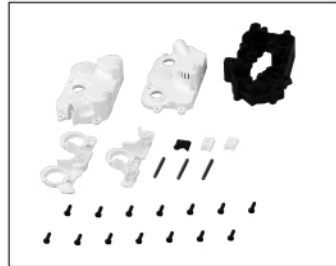

PV1050 3 IN 1 SERVOGEHÄUSE



PV1051 HAUPTZAHNRAD SET

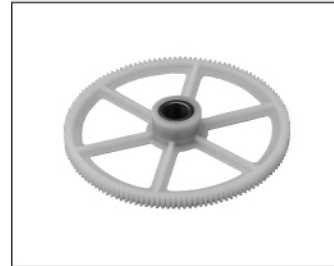

PV1052 HAUPTZAHNRAD



PV1053 FREILAUFHÜLSE

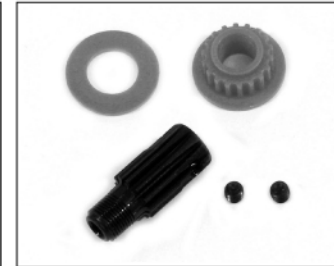

PV1054 RITZEL HECKANTRIEB



PV1055 HECKROHR KURZ



PV1057 HECKKRIEMEN 400ER

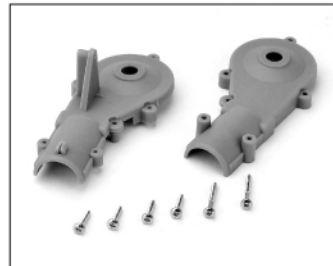

PV1059 HECKKROTORGEHÄUSE

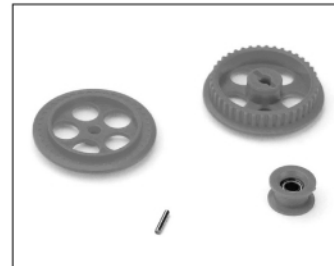

PV1060 HECKKRIEMENRAD SET (40T)



PV1061 HECKKROTORWELLE (2)



PV1062 HECKKROTORSCHEIBENSET

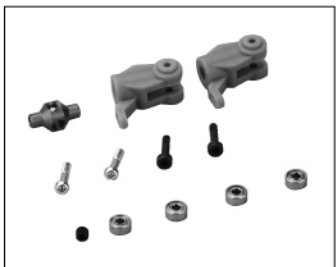

PV1063 HECKKROTORSET



PV1064 HECKKROTORBLATTHALTER



PV1065 HECKKROTORNARBE



PV1066 STD HECKKROTORBLÄTTER



PV1067 EXP HECKKROTORBLÄTTER



PV1068 SEITENLEITWERK EXP



PV1069 MD530 RUMPF BLAU



PV1071 EXP HAUBE WEIß

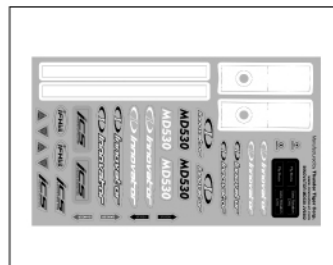

PV1074 DEKORBÖGEN MD530

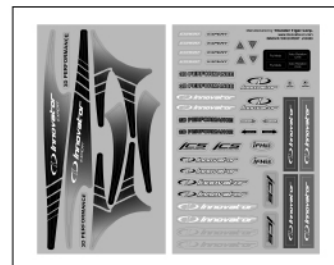

PV1075 DEKORBÖGEN EXP

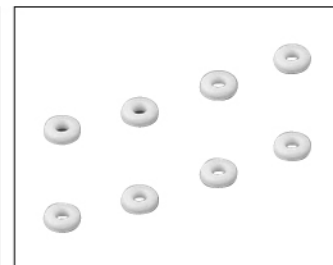

PV1076 GUMMITÜLLEN

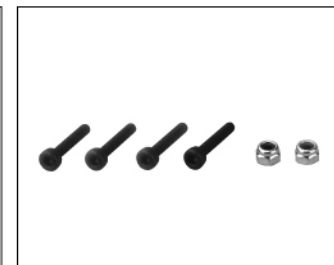

PV1077 HAUPTKROTORWELLEN
SCHRAUBEN

TEILELISTE ABSCHNITT

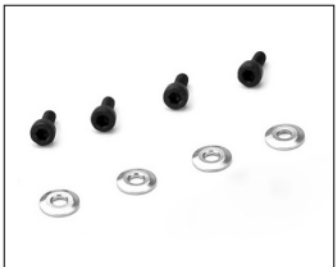

PV1078 MOTORTRÄGER SCHRAUBENSATZ

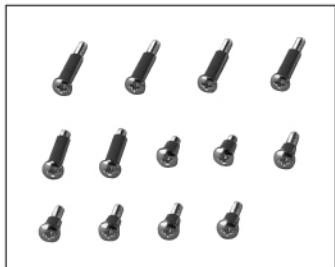

PV1079 BUNDSCHRAUBEN SET

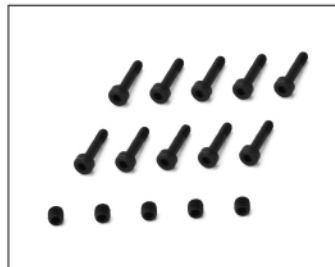

PV1080 HECKROTOR SCHRAUBEN SET

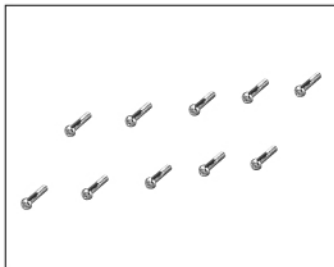

PV1081 HECKROTORBLATTHALTER
SCHRAUBEN SET

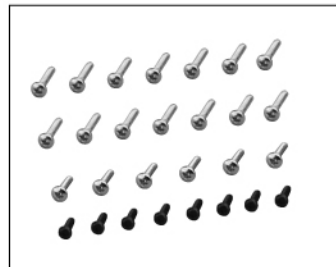

PV1082 CHASSIS SCHRAUBENSATZ

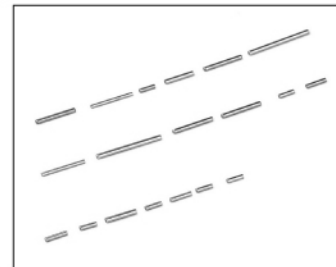

PV1084 BOLZEN SET



PV1085 KUGELLAGER FÜR PITCHKOMPENSATORARME &
HECKBLATTHALTER



PV1086 DOMLAGER

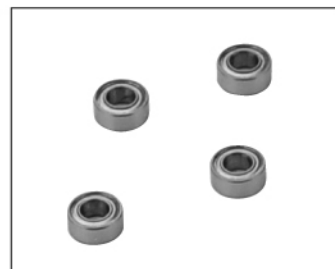

PV1087 KUGELLAGER
FÜR PADDELHEBEL



PV1088 HAUPTROTORBLATTHALTER
KUGELLAGER

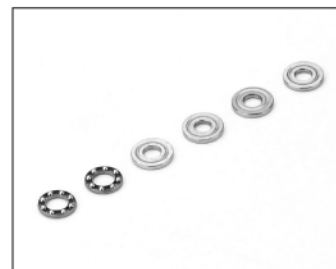

PV1089 DRUCKLAGER

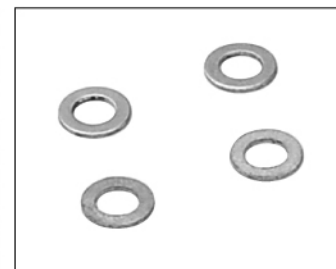

PV1090 DRUCKSCHEIBEN



PV1091 KUGELLAGER HECKROTORGEHÄUSE

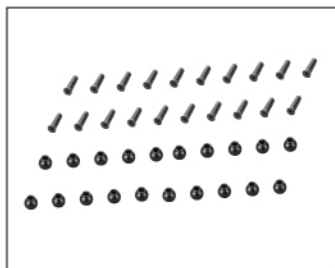

PV1092 KUGELKOPFSCHRAUBEN SET



PV1093 POTENTIOMETER

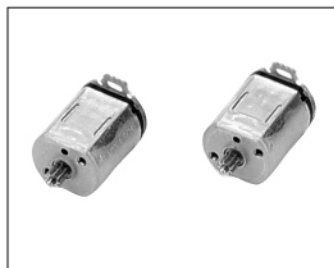

PV1094 SERVO MOTOR (2)



PV1095 SERVO LEITUNGS SET



PV1096 GOLDKONTAKTSTECKER (2MM)



PV1097 STECKER FÜR REGLER

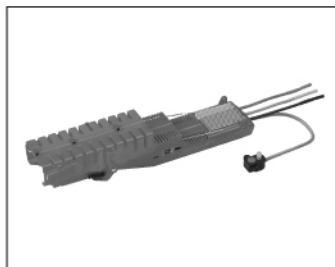

PV1098 ICS FÜR STD KPL.

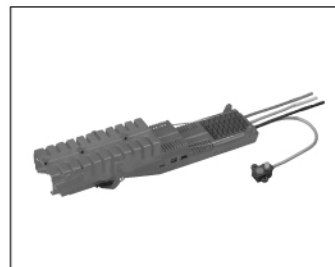

PV1099 ICS FÜR EXP KPL.

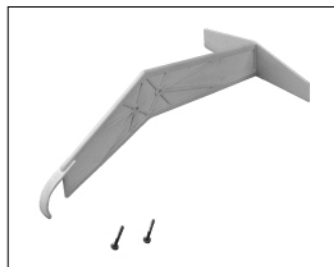

PV1100 SEITENLEITWERK MD530



PV1101 ROTORBLATTHALTER /
CADDY MD530

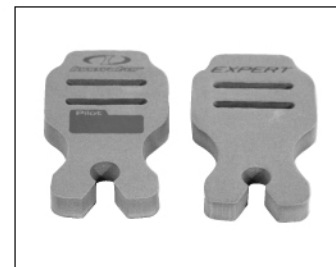

PV1102 ROTORBLATTHALTER /
CADDY EXP

TEILELISTE ABSCHNITT



PV1119 SCHRAUBENSATZ BLATTHALTER



PV1122 HECK SERVO MOTOR



PV6046 SCHAUMROTORBLÄTTER
GROßPACKUNG (3 SETS)



2349 MOTOR EXP 3800KV



2383 MOTOR STD 3500KV

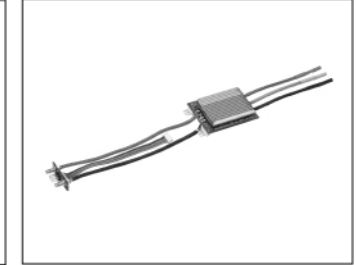

AQ2234 DREHZAHLEGLER STD 35 A

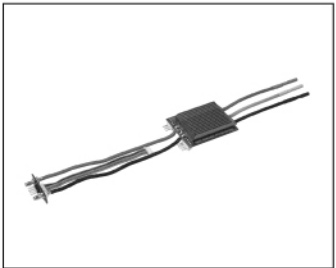

AQ2235 DREHZAHLEGLER EXP 55 A

OPTIONALE TEILE



3877 CFK HAUPTROTORBLÄTTER 300MM

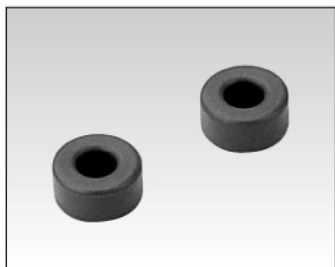

PV1013 DÄMPFERGUMMIS (80 R)

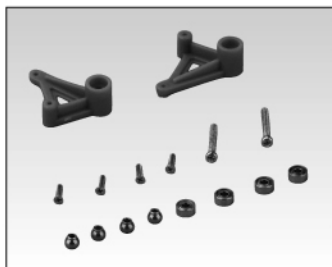

PV1041 ROLLARME MIT KUGELLAGER



PV1056 HECKROHR LANG



PV1058 HECKKRIEMEN 448ER

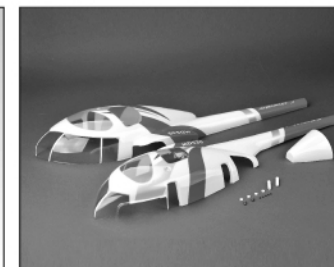

PV1070 MD530 RUMPF ROT



PV1072 EXP HAUBE GELB

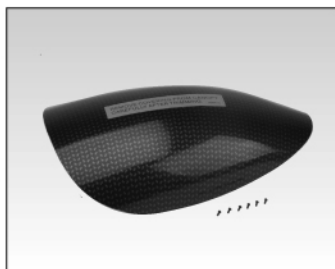

PV1073 EXP HAUBE CARBON

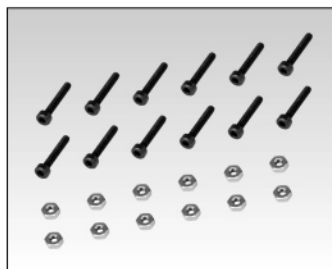

PV1083 CHASSIS SCHRAUBEN SET

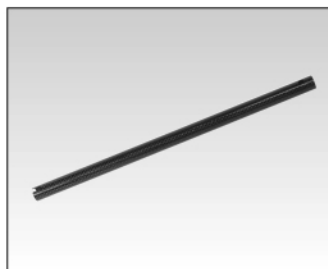

PV1103 CFK HECKROHR, KURZ

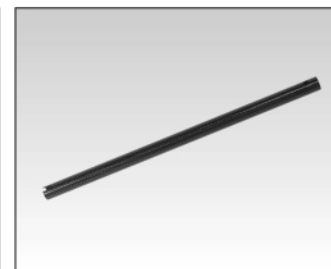

PV1104 CFK HECKROHR, LANG



PV1105 ALU TAUMELSCHIEBE



PV1106 METALLGETRIEBE FÜR SERVO

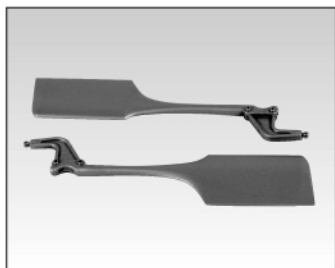

PV1107 3D PADDEL



PV1108-G GFK KANZEL FÜR MD530 GRÜN



PV1108-L GFK KANZEL FÜR MD530 BLAU



PV1108-O GFK KANZEL FÜR MD530 ORANGE

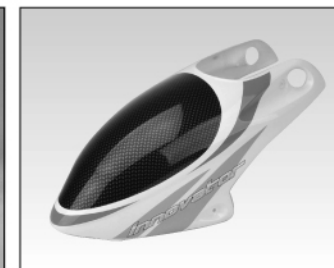

PV1109 GFK KANZEL FÜR EXP / 3D



PV1111 MOTORRITZEL SET 11/18T



PV1112 MOTORRITZEL SET 13/18T



PV1113 MOTORRITZEL SET 12/18T



PV1114 ALU RIEMENRAD

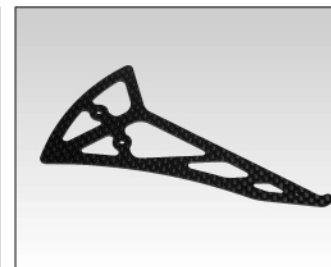

PV1115 CFK SEITENLEITWERK

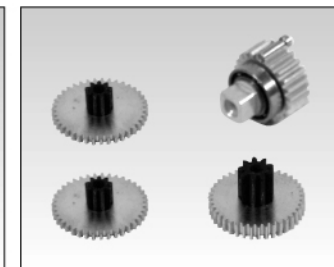

PV1117 METALLGETRIEBE HECKROTORSERVO

OPTIONALE TEILE

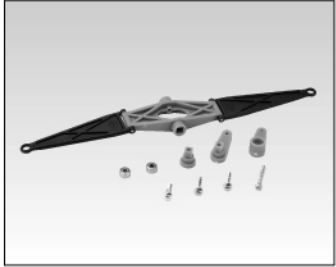

PV1118 NICKARMSET MIT KUGELLAGER

MAIN ZUBEHÖR



1075 KUGELKOPF ZANGE

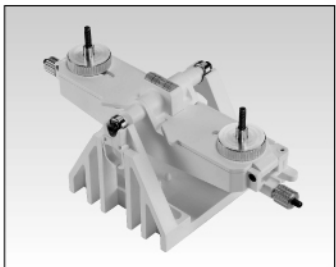

1077 ROTORBLATTWAAGE



1078 PITCHLEHRE

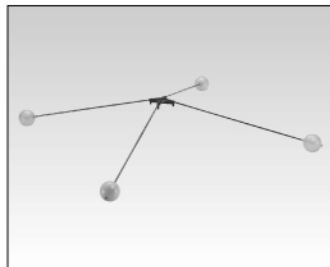

1079 TRAININGSGESTELL



1082 WERKZEUGSET INNOVATOR



1083 GETRIEBEFETT



1084 KUGELGELENKEINDREHWERKZEUG



1085 SENDER UMHÄNGERIEMEN

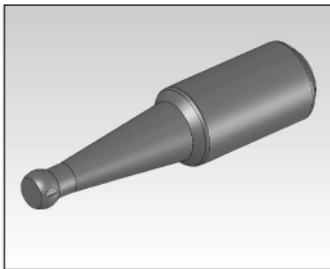

1198 KUGELKOPFREIBAARE 3,8MM



1385 INNOVATOR CAP



1392 MONTAGEMATTE



2708 INNOVATOR SOFTWARE



2815 LIPO AKKU INNOVATOR
(1800MAH / 15C)



2816 LIPO AKKU INNOVATOR
(1800MAH / 25C)



2817 LIPO AKKU INNOVATOR
(2000MAH / 25C)



8605 TS6 SENDER



1386 POLO SHIRT INNOVATOR



2946-I SENDERAKKU INNOVATOR
9,6V/ 1100MAH



AC2262 2,4GHZ ANTENNE TS6 SENDER



AC2266 2,4GHZ EMPFÄNGER ANTENNE



AQ2240 LADEGERÄT LIPO AKKUS 12V



AQ2254 FUTABA 2,4GHZ SENDERMODUL



AQ2271 GRAUPNER 2,4GHZ
SENDERMODUL



AT0155LEHRER/SCHÜLERKABEL

MAIN ZUBEHÖR



PV0761 SCHAUBENSICHERUNGS
LACK



AT2140 LADEGERÄT INNOVATOR
230V, 2P, 110MA



AT2139 LADEGERÄT INNOVATOR
110V, 2P, 110MA



AT2139-J LADEGERÄT INNOVATOR
110V, 3P, 110MA



AT2141 LADEGERÄT INNOVATOR
230V, 3P, 110MA



Innovator EXPERT



Innovator MD530

Technische Daten und Inhalt

Modellname	Innovator MD530	Innovator EXPERT
Länge	650mm	650mm
Breite	135mm	135mm
Höhe	265mm	245mm
Hauptrotordurchmesser	712mm	712mm
Heckrotordurchmesser	150mm	135mm
Getriebeübersetzung	1:11:4.95	1:11:4.95
Gesamtgewicht	840g	825g
Rotorblätter	Spezielschaum	Holz
Stabilizer	STD version	EXP version
Motor	S1/KV3500	S2/KV3800
Akku	3S1P 1800mAh/15C	3S 1P 1800mAh/25C
Drehzahlregler	35A	55A
Standard Flugdaten	PCS-NOR-HOV-0001	PCS-NOR-SPORT-0001

Exclusive for the INNOVATOR R/C Helicopter
www.innovator-rc.com

INNOVATOR Website : www.innovator-rc.com

© 2009

Manufactured by **THUNDER TIGER CORP.**
www.thundertiger.com

JK0319-G