

HUBSCHRAUBER

**Schlüter**

MODELLBAU

Ing. Dieter Schlüter · Dieselstraße 5 · 6052 Mühlheim am Main · West Germany

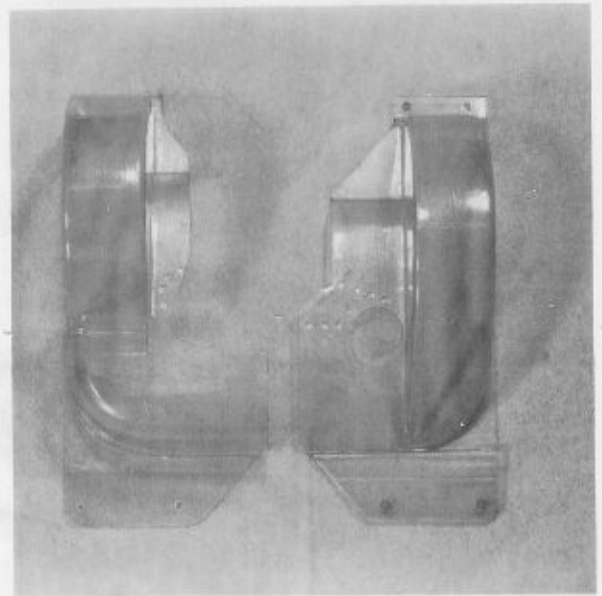
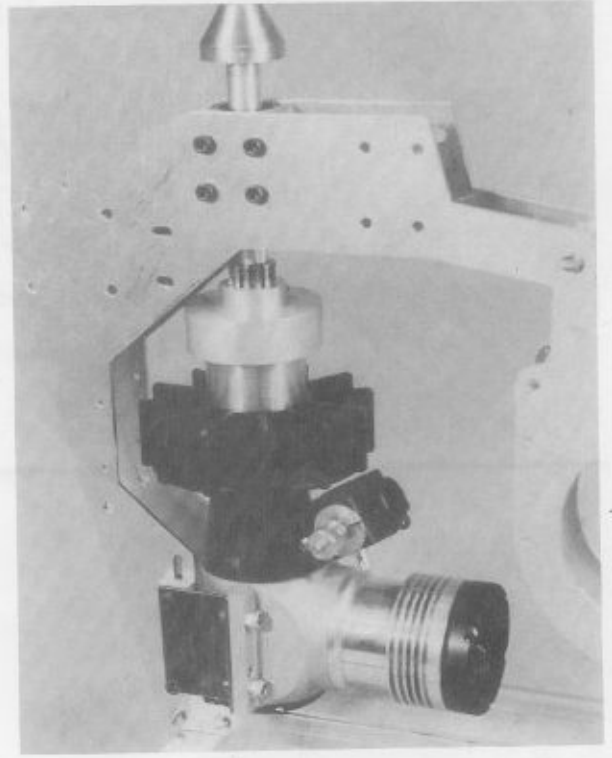
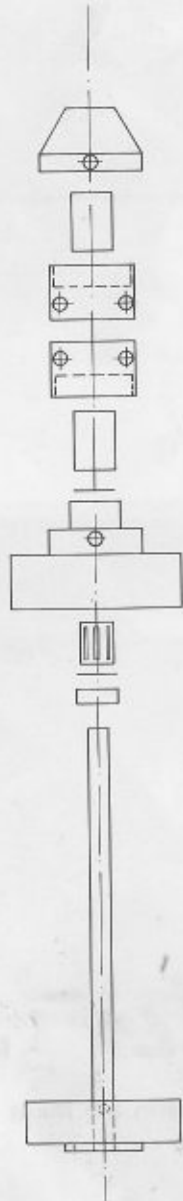
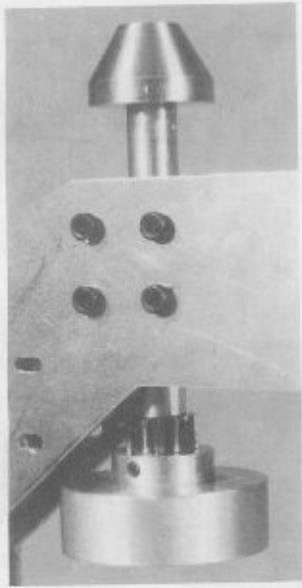
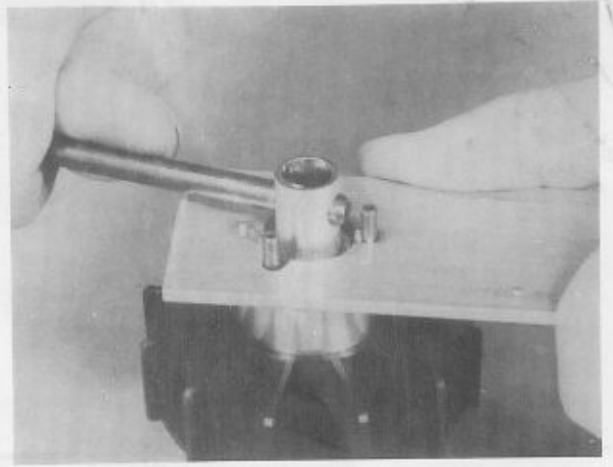
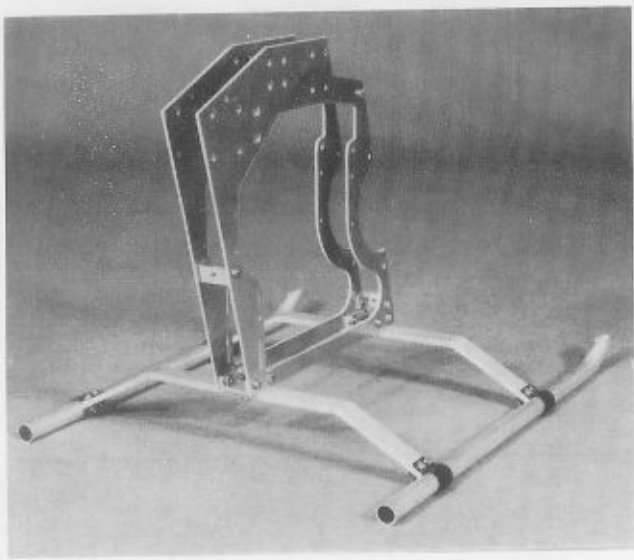

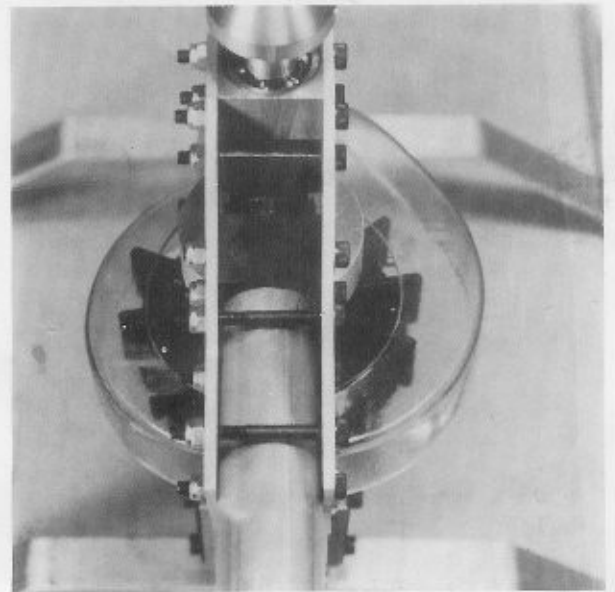
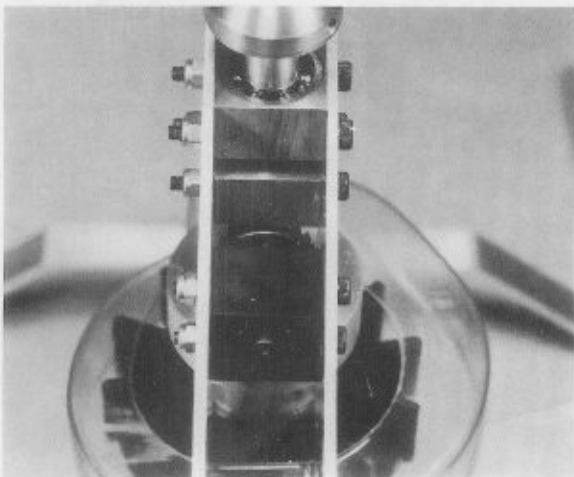
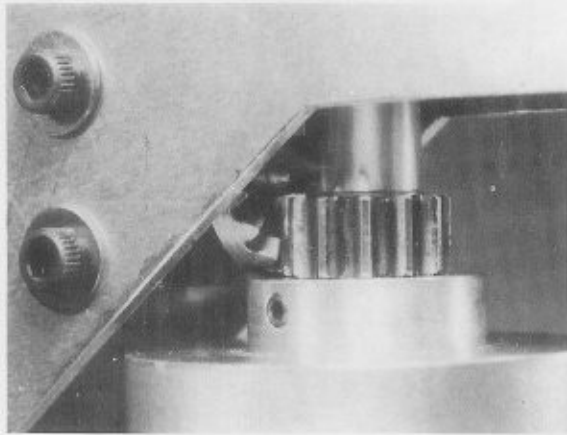
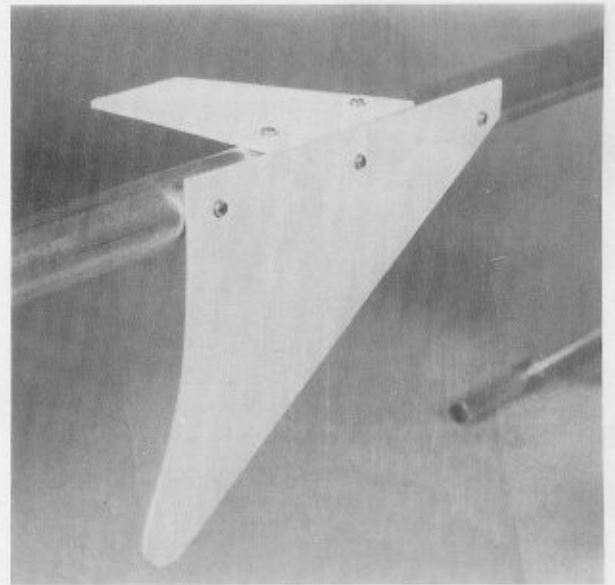
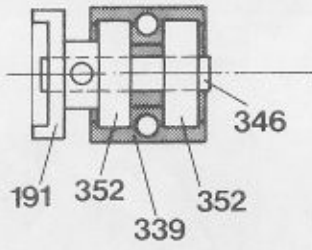
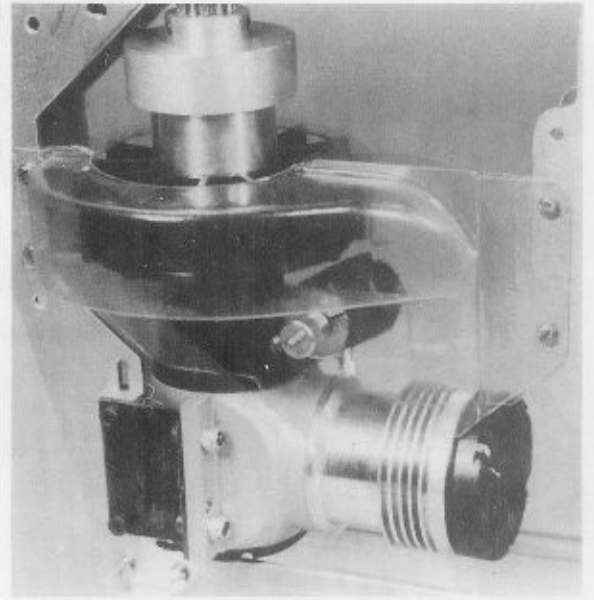
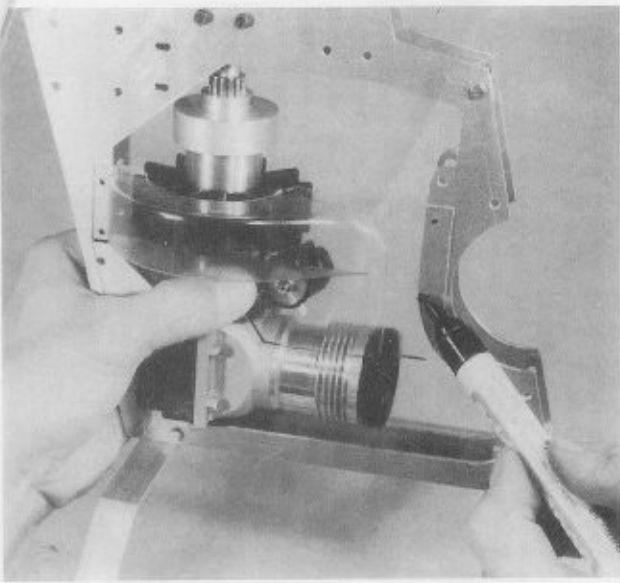

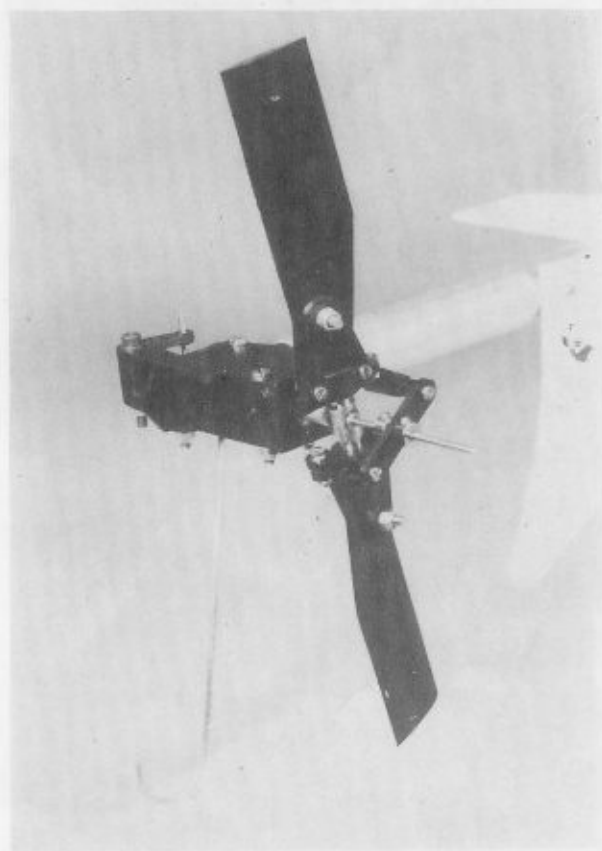
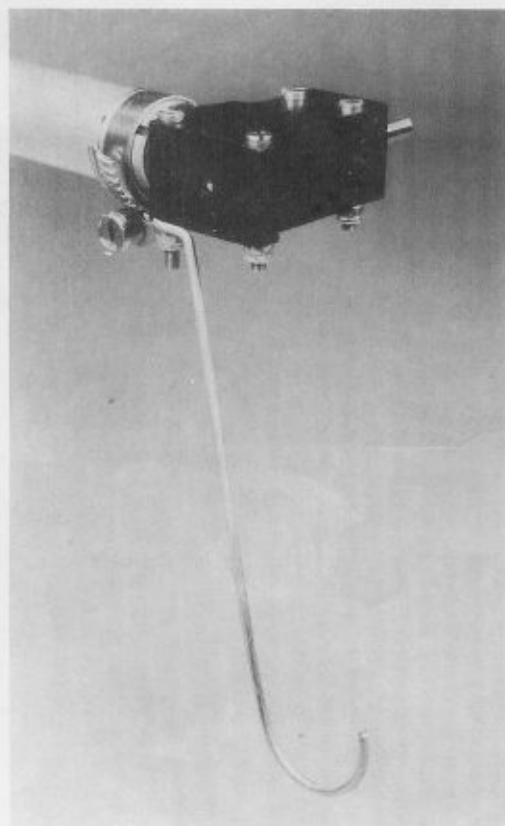
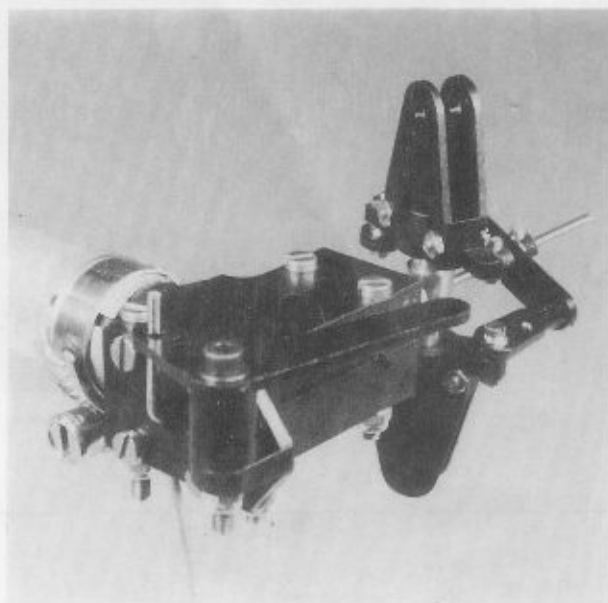
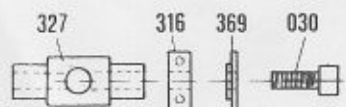
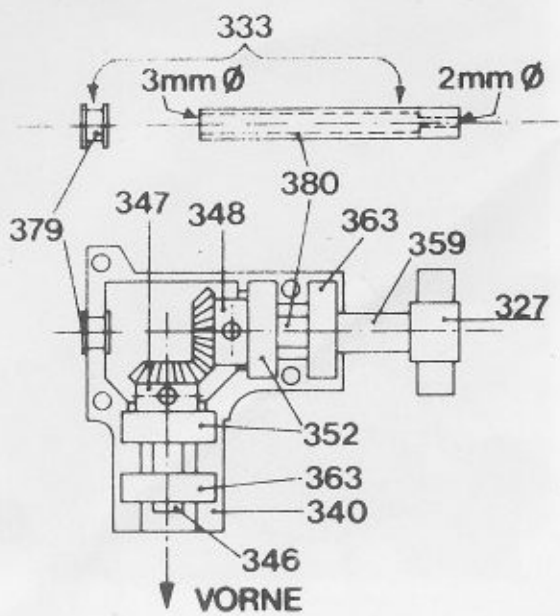

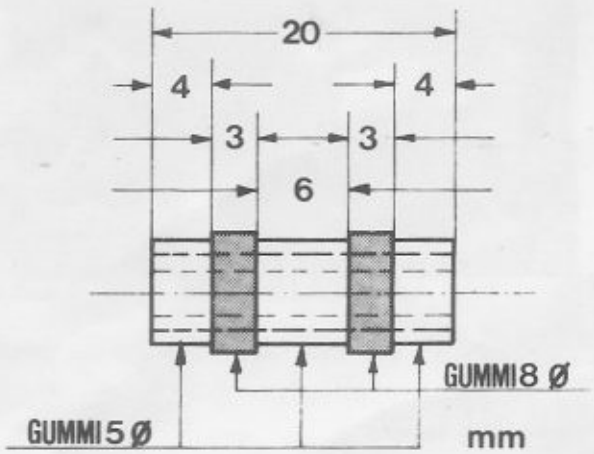
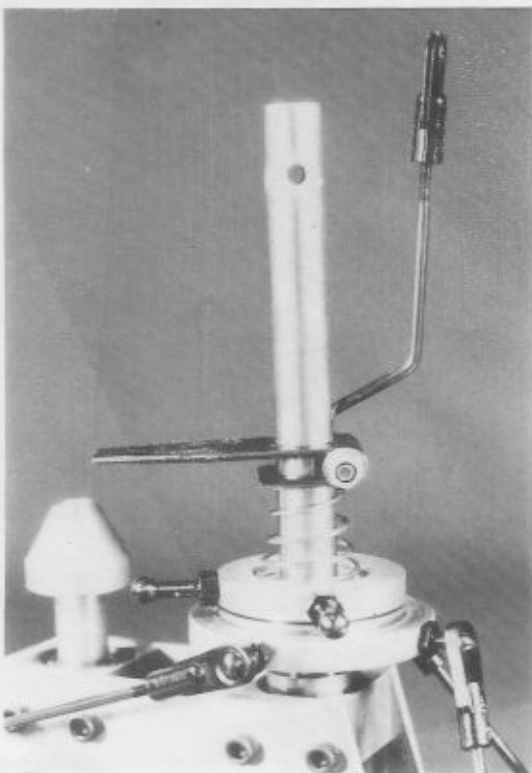
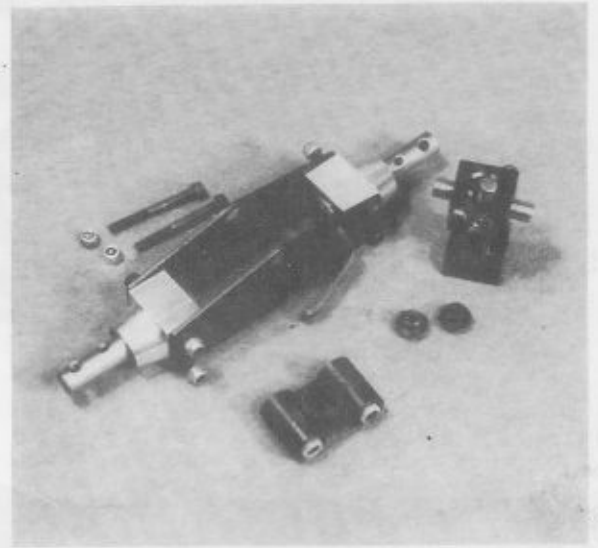
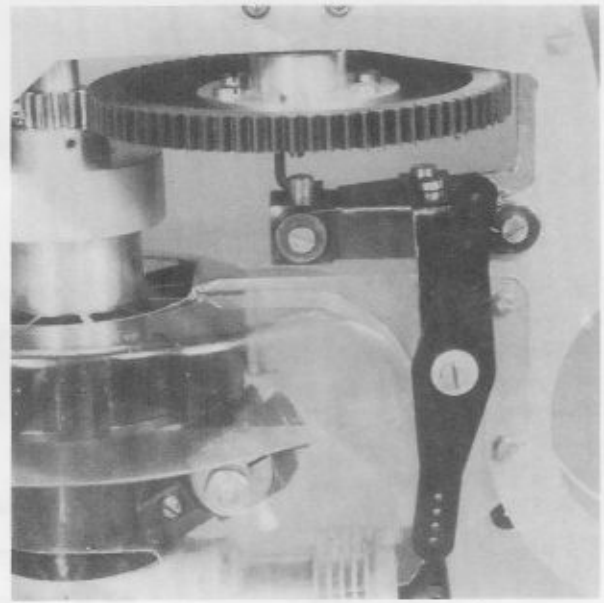
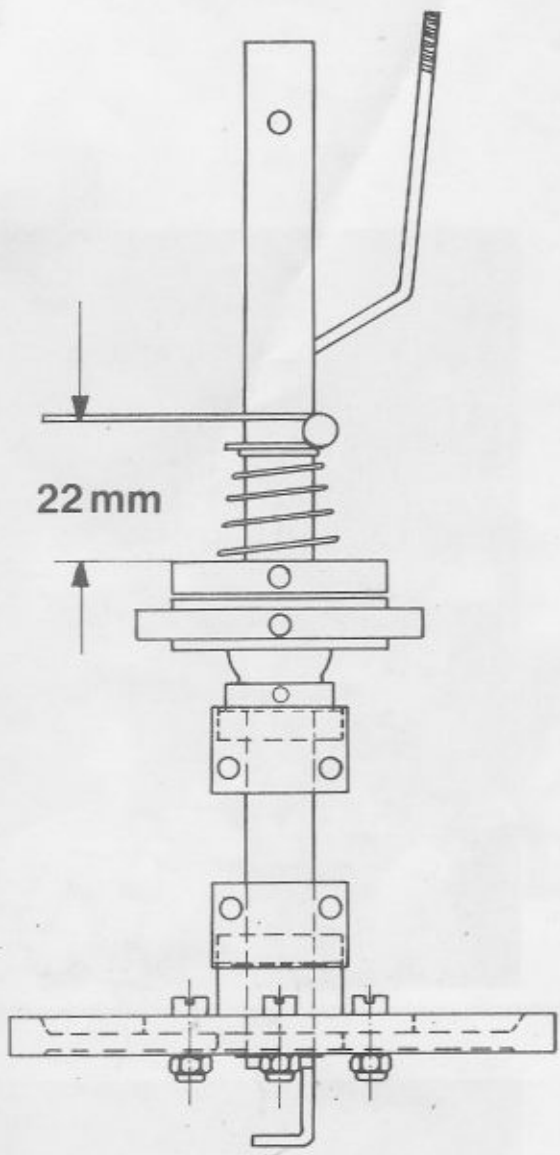

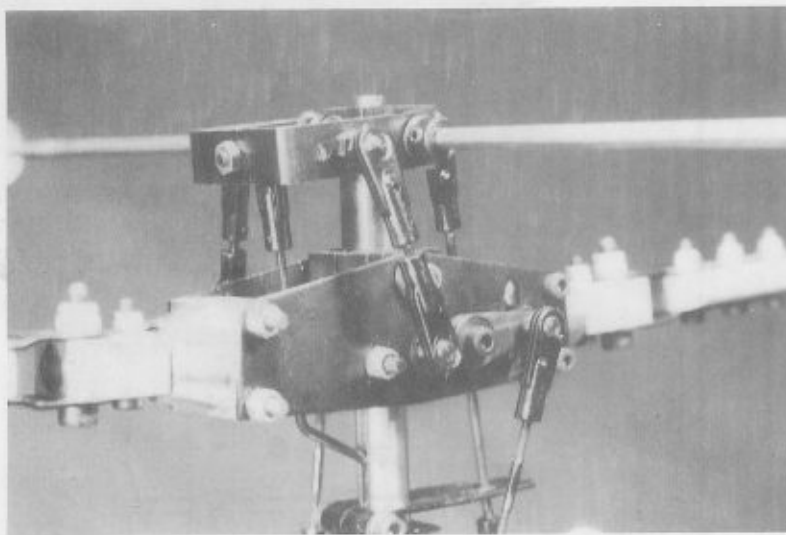
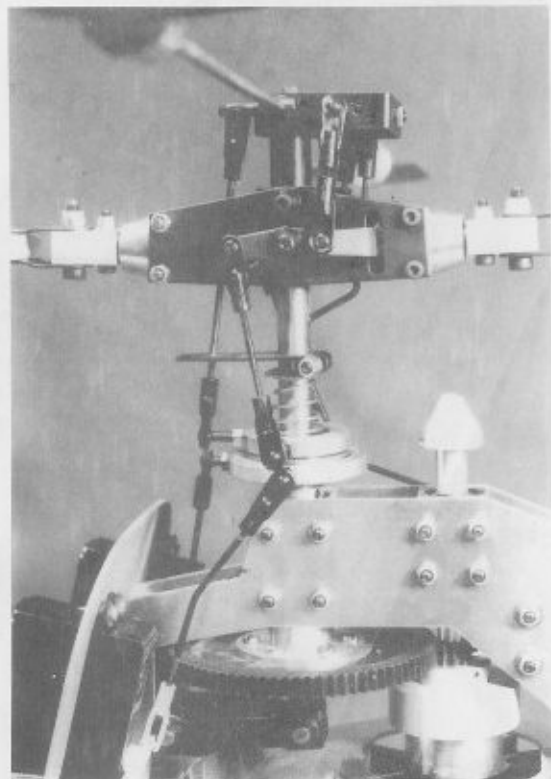
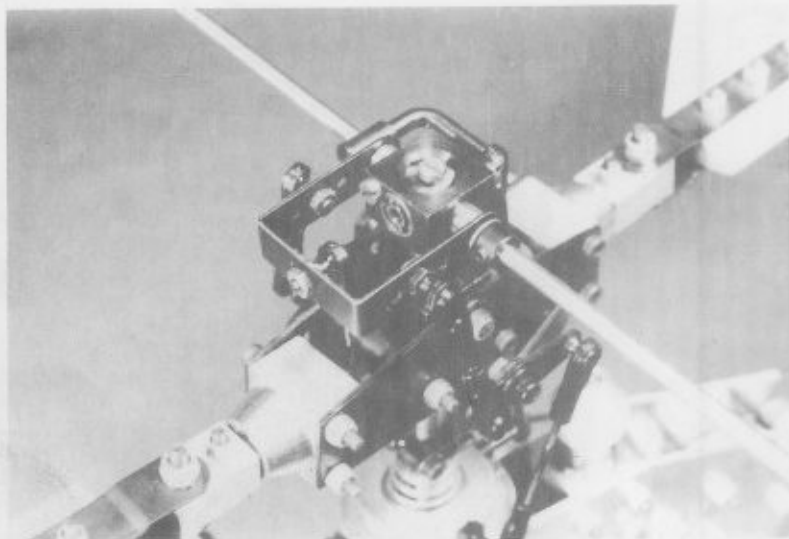
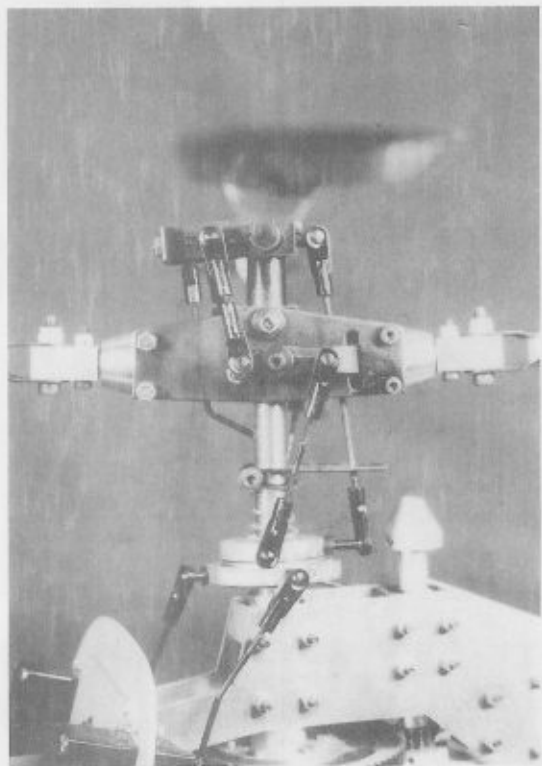
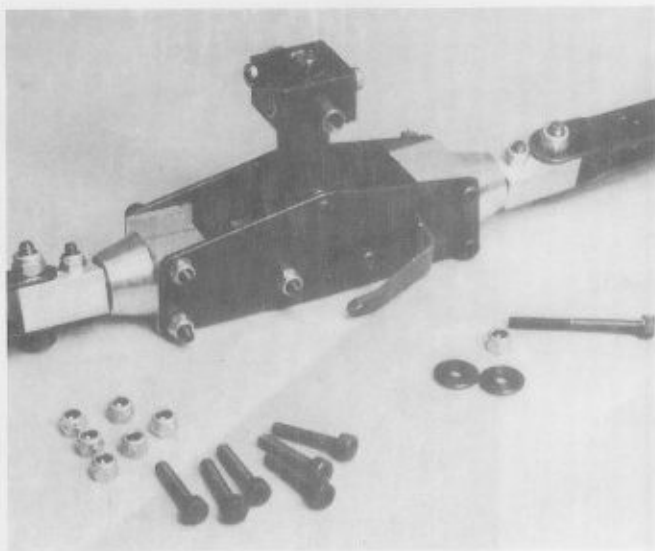

**Motor  
Engine**

**Auffüllen  
Fill up**

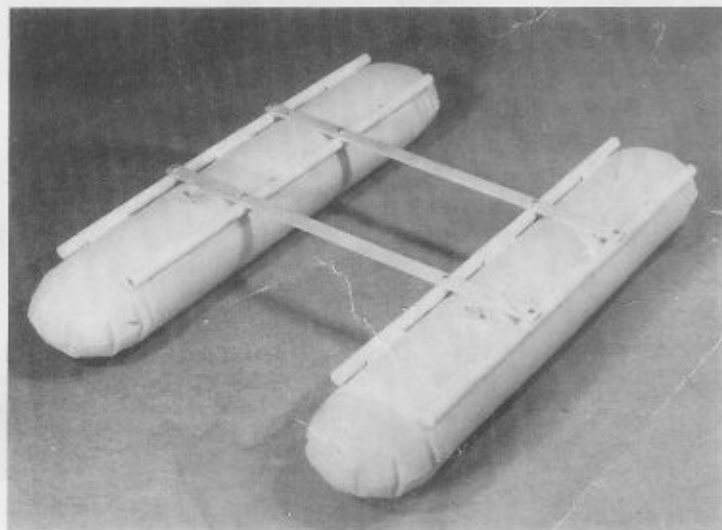
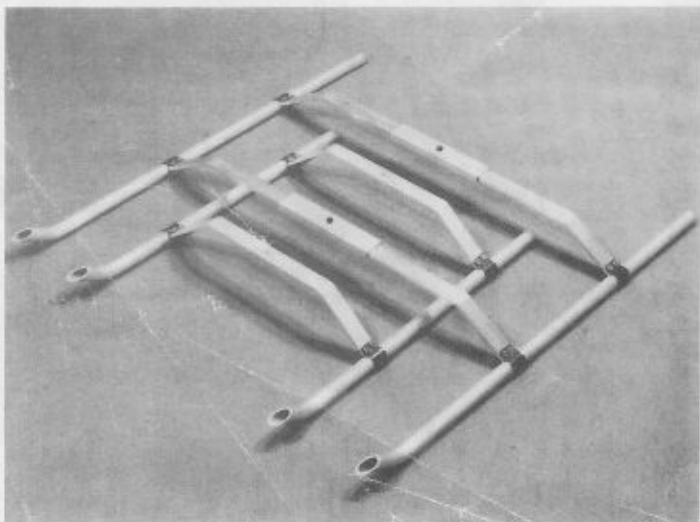
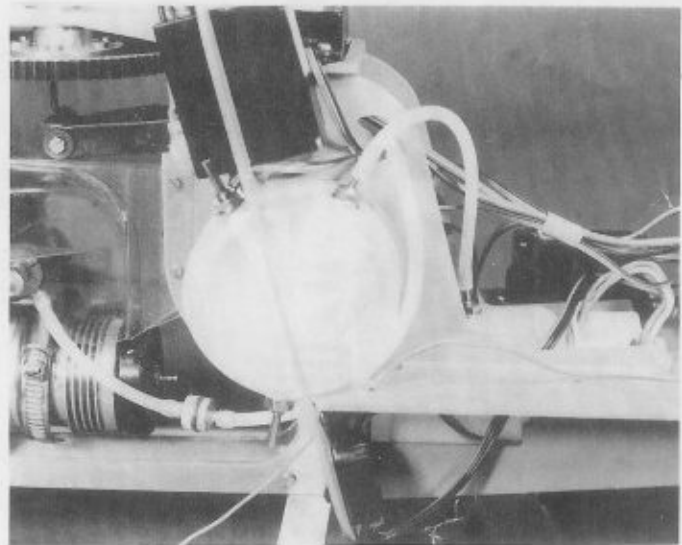
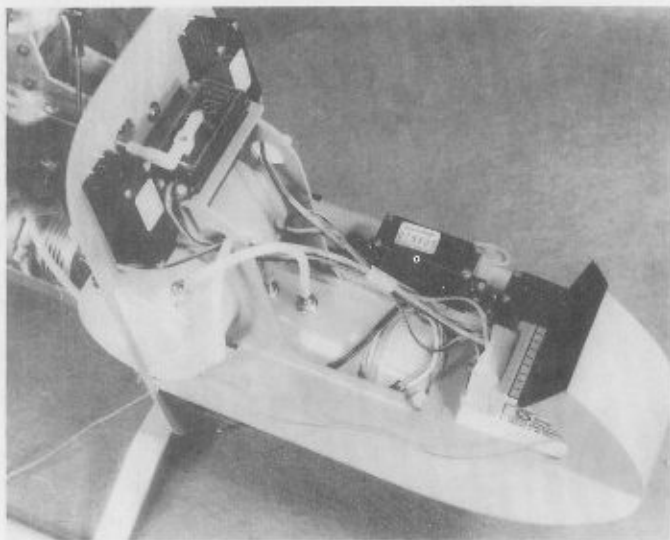
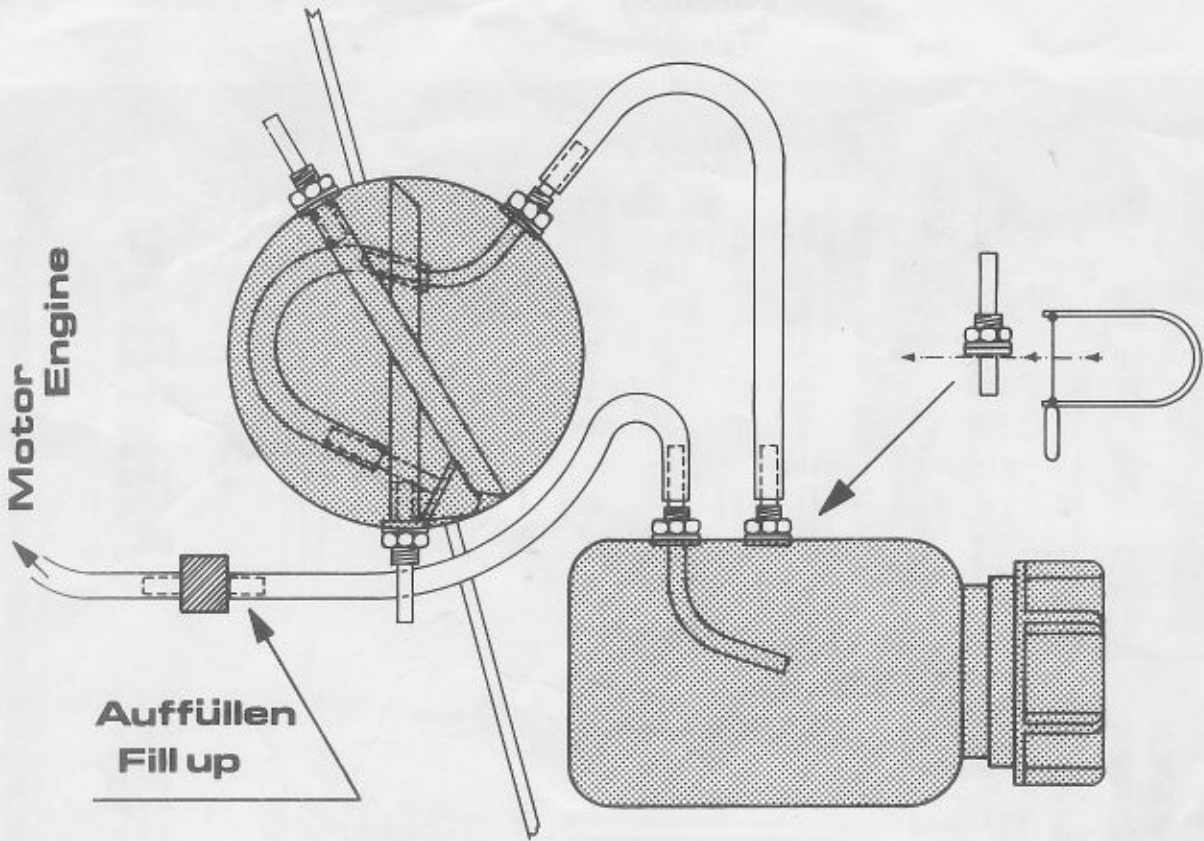



1



2



3



4

5



6



7

8



8

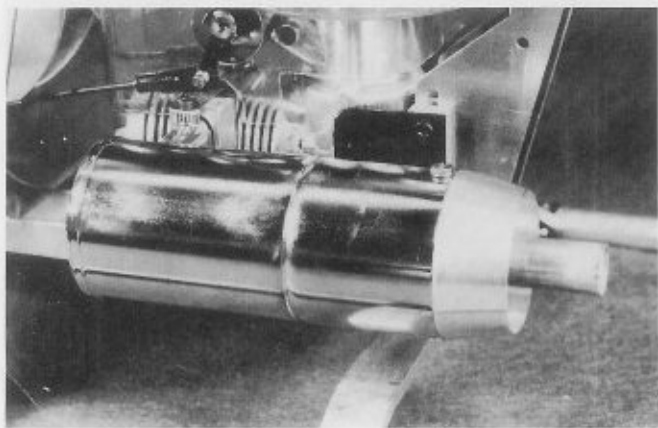
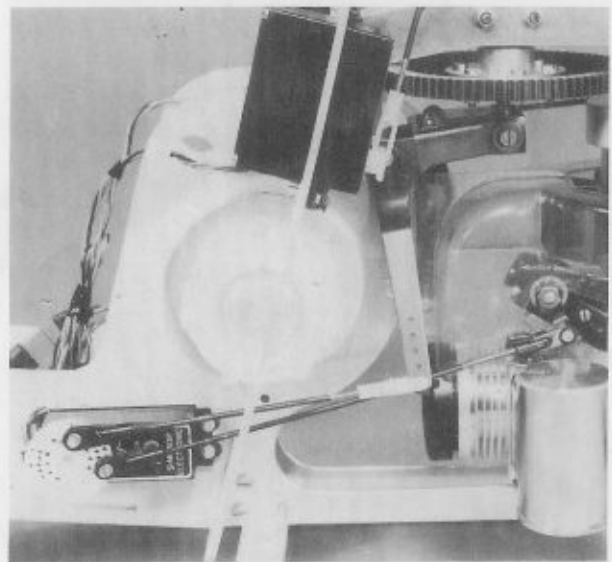
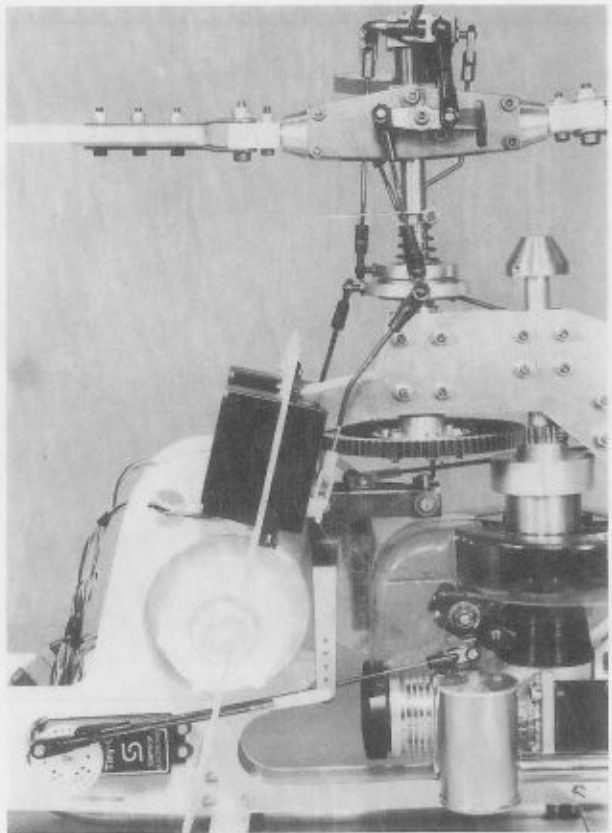
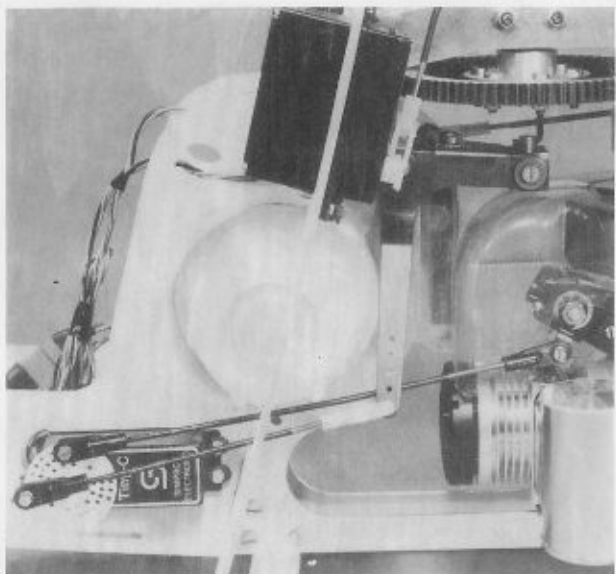
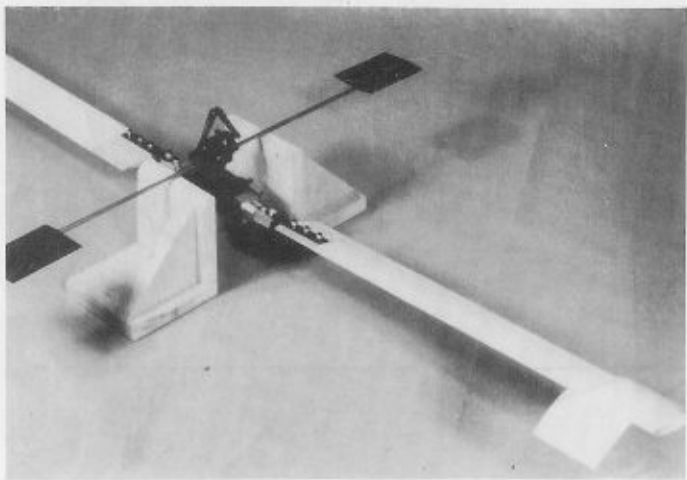



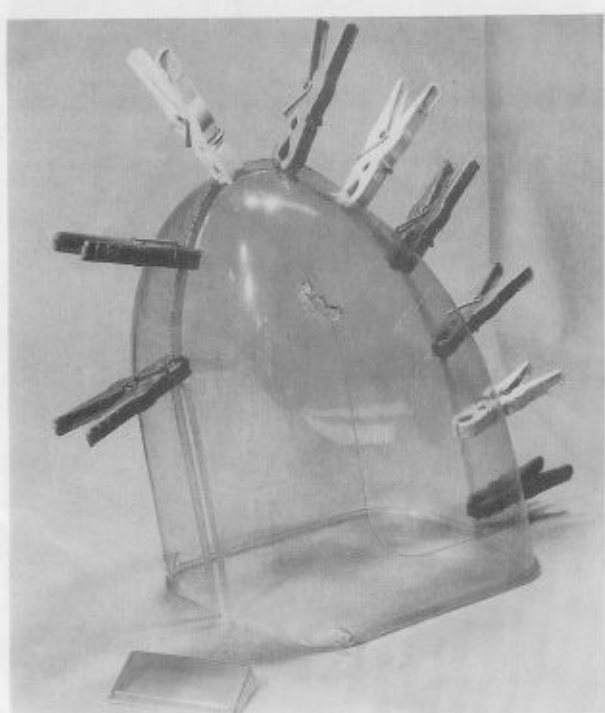
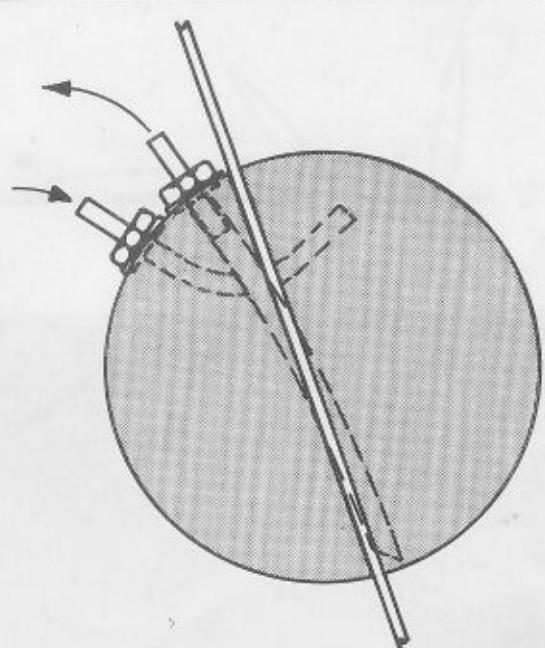
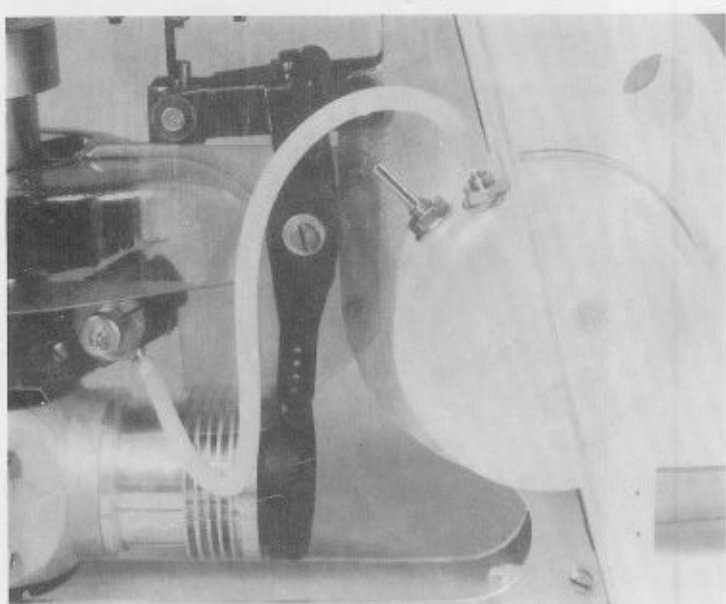
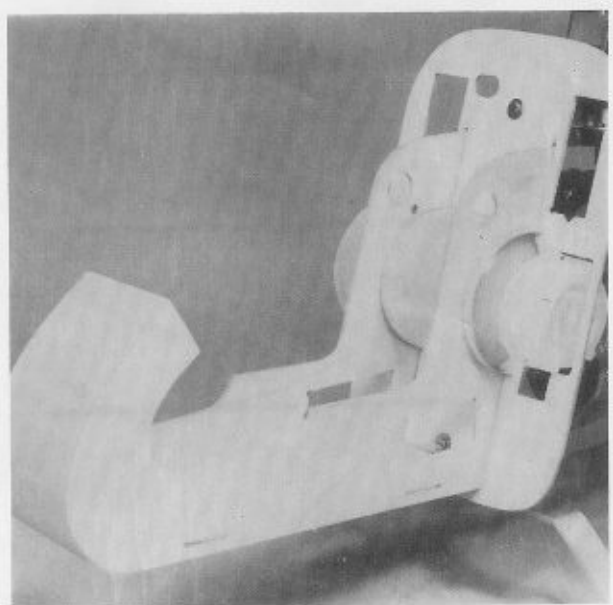
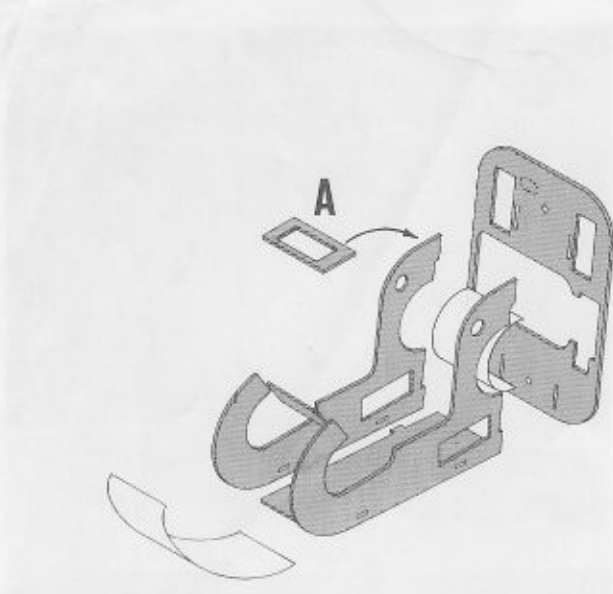

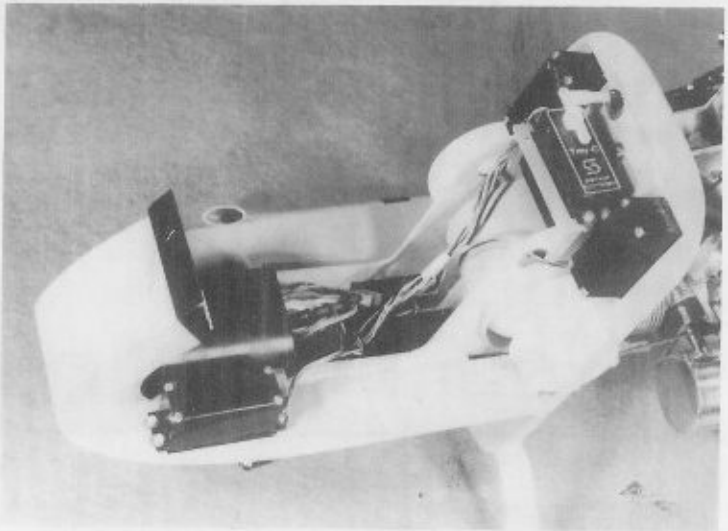
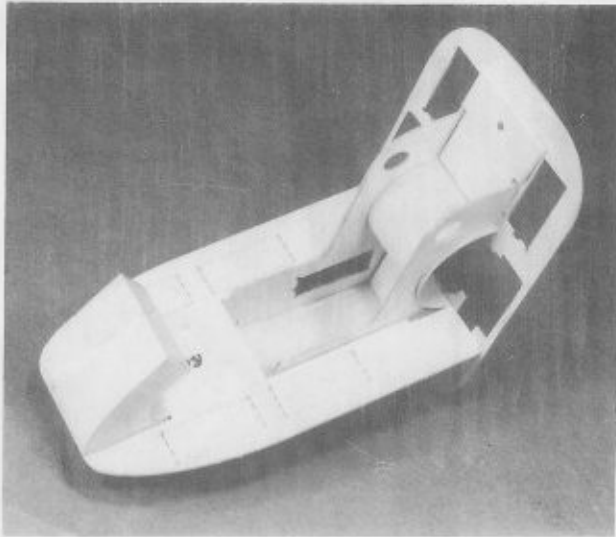
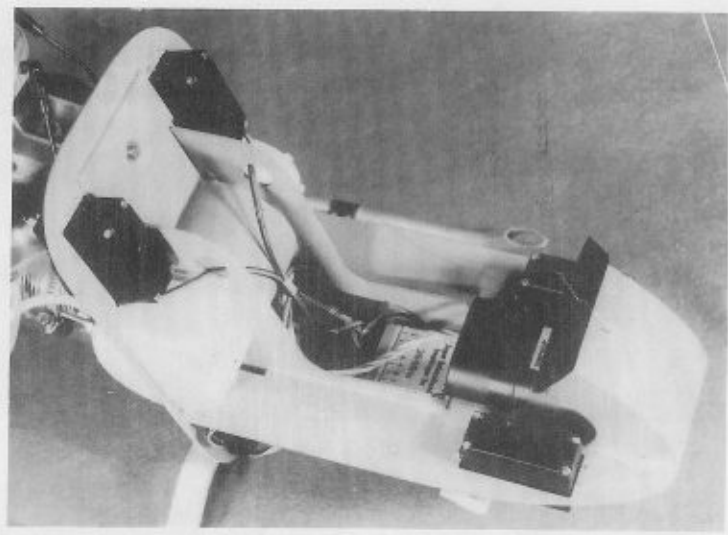
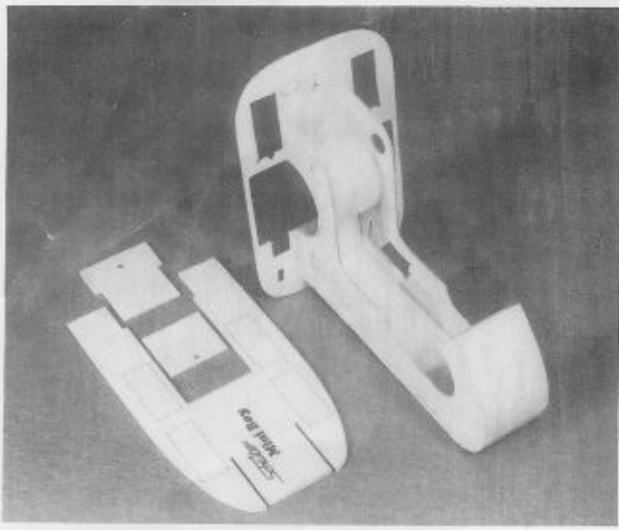

*Schlüter*

