

AVCS GYRO
GY502
INSTRUCTION MANUAL

**YAW-AXIS STABILIZER FOR MODEL HELICOPTER
(RATE GYRO)**

Thank you for buying a GY502 AVCS gyro.

Before using your new gyro, please read this manual thoroughly and use the gyro properly and safely. After reading this manual, store it in a safe place.

FOREWORD

The GY502 is an AVCS (Angular Vector Control System) rate gyro developed for use with .60 type and other model helicopters.

[Features]

- High-speed arithmetic processing by microcomputer allows high-speed pulse drive of servos. (Compatible with high-speed digital servos)
- Sensor vibration resistance and neutral characteristics have been improved by the use of a low back aerofoam case.
- Amplifier mounts an LCD for accurate data setting.

[Applicable servos]

Gyro performance largely depends on the servo used. The higher the speed and response of the servo, the higher the gyro gain and the better the gyro performance. From this standpoint, a digital servo is perfectly suited for use with a gyro. We recommend the use of a high-speed digital servo especially developed for gyro use.

-
- No part of this manual may be reproduced in any form without prior permission.
 - The contents of this manual are subject to change without prior notice.
 - This manual has been carefully written. Please write to Futaba if you feel that any corrections or clarifications should be made.

TABLE OF CONTENTS

FOR SAFETY

- Meaning of Special Markings ----- 4
- Mounting/Operating Precautions ----- 5
- Fuselage Maintenance Precautions ----- 7

BEFORE USE

- Set Contents ----- 8
- AVCS Gyro ----- 9
- Digital Servo Compatibility ----- 11

DATA SETTING

- Name and Function of Each Part ----- 12
- LCD Display and Edit Keys ----- 13
- Function Map ----- 14
- GY502 Functions Setting ----- 15
- Remote Gain Function ----- 21
- Initialization ----- 30

INSTALLATION AND ADJUSTMENT

- Installing to Fuselage ----- 32
- Flight Adjustments ----- 37

REFERENCE



- Specifications ----- 40
- Definition of Abbreviations ----- 41
- GY502 Parameters Sheet ----- 42

FOR SAFETY

To ensure safe use, observe the following precautions.

Meaning of Special Markings

Pay special attention to the safety at the parts of this manual that are indicated by the following marks.

Mark	Meaning
 Danger	Procedures which may lead to a dangerous condition and cause death or serious injury to the user if not carried out properly.
 Warning	Procedures which may lead to a dangerous condition or cause death or serious injury to the user if not carried out properly, or procedures where the probability of superficial injury or physical damage is high.
 Caution	Procedures where the possibility of serious injury to the user is small, but there is a danger of injury, or physical damage, if not carried out properly.

Symbol:

 ; Prohibited

 ; Mandatory

Mounting/Operating Precautions

⚠ Warning

- ❗ **Insert the connectors fully and firmly.**

If a connector works loose due to vibration during flight, control may be lost and result in a dangerous situation.

⚠ Caution

- ❗ **Always use the accessory sensor tape to install the sensor to the fuselage.**

This is necessary to securely fasten the sensor to the fuselage so that operation of the gyro does not transmit unwanted fuselage vibrations directly to the sensor.

- ❗ **When mounting the sensor, provide a little surplus so that the sensor connection cables are not too taut.**

If the sensor cables are too taut, the gyro will not display its full performance. If the sensor peels, control will be lost and result in a dangerous situation.

- ❗ **Mount the sensor and control amp so that metals or other conductive objects do not touch these cases.**

The GY502 uses a conductive resin case to reduce electromagnetic interference. Because the surface of the case is conductive, metal objects may cause a short circuit.

- ❗ **Mount the sensor and servo at least 2cm apart.**

When using a GV-1 governor, mount the sensor and GV-1 amp at least 5cm apart.

When using the GY502 with a motor-driven helicopter, mount the sensor and drive motor at least 10cm apart.

Noise from the servo motor, GV-1 amp and drive motor may cause the performance of an erroneously operated gyro to drop.

Precautions When Turning on the Power Switch

During initialization, the message “-Hello-” appears on the GY502 LCD screen.

- ⊘ **Do not move the helicopter until this message disappears (in about 3 seconds).**
- ⊘ **Also, do not move the transmitter rudder stick from the neutral position during this period.**

- ❗ **Always check the direction of operation of the servos.**

If you attempt to fly the model when a servo operates in the wrong direction, the fuselage will spin in a fixed direction and enter an extremely dangerous state.

- ❗ **When the rudder neutral position was changed by the linkage, the rudder neutral position in the AVCS mode must always be re-read before use.**

Re-reading method:

Turn on the transmitter in the AVCS mode, then turn on the gyro . Or quickly switch (interval of within 1 second) the remote gain channel switch between the AVCS mode and Normal mode at least three times and switch the AVCS side with the transmitter in the ON state. This memorizes the new rudder position inside the GY502.

- ❗ **Avoid sudden temperature changes.**

Sudden temperature changes will cause the neutral position to change. For example, in the winter, do not fly immediately after removing the model from inside a heated car and in the summer, do not fly immediately after removing the model from inside an air conditioned car. Allow the model to stand for about 10 minutes and turn on the power after the temperature inside the gyro has stabilized. Also, if the gyro is exposed to direct sunlight or is mounted near the engine, the temperature may change suddenly. Take suitable measures so that the gyro is not exposed to direct sunlight, etc.

- ❗ **Check the remaining receiver/gyro/servo nicd battery operating time during the adjustment stage and decide how many flights are remaining.**
- ⊘ **Never use the transmitter rudder trim in the AVCS mode.**
When the rudder is trimmed during flight, the neutral position will change.
- ❗ **When using the GY502 in the AVCS mode, set revolution mixing to OFF.**

Fuselage Maintenance Precautions

⚠ Caution

- ❗ **Use a tale rotor drive tube or other part with a high torsion performance for the tail drive.**
- ❗ **Take the strength of the tail into account during inspection and adjustment.**

The amount of improvement of gyro performance has a considerable effect on the fuselage vibration level or the size, type, linkage method, looseness, etc. of the tail rotor.

Since a higher gain than usual can be used then the tail rotor is more effective, the load on the tail is also greater.

- ❗ **Always perform proper maintenance for ultimate performance.**
The rigidity of the fuselage tail has a large effect on gyro performance.
- ❗ **Make the fuselage vibration as small as possible.**
Fuselage vibration has an adverse affect on gyro operation.

BEFORE USE

Set Contents

After unpacking the GY502 set, first check if the following parts are provided:

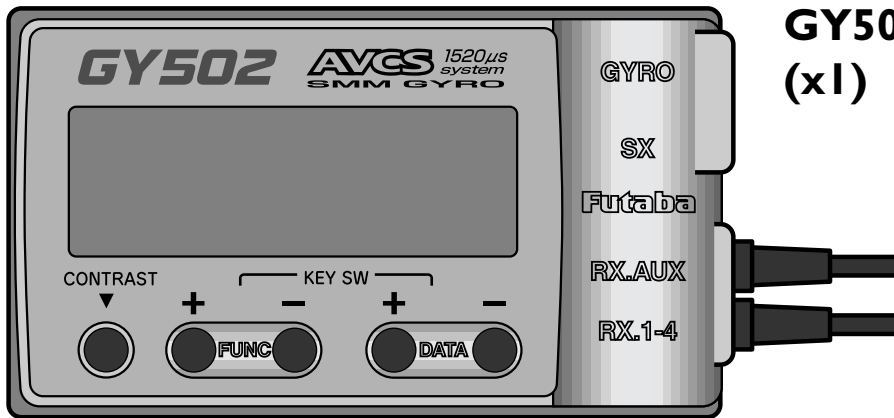

GY502 control amp (x1)

GY502 sensor (x1)



Sensor tape (x3)

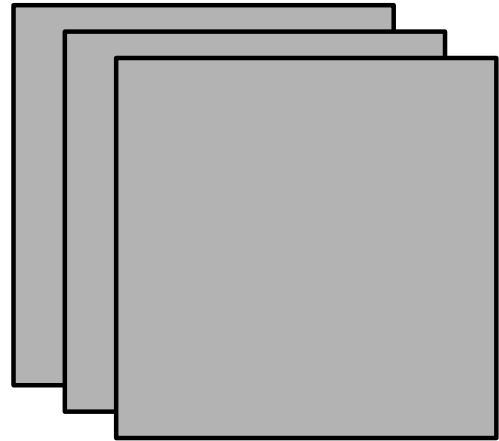

Mini screwdriver (x1)

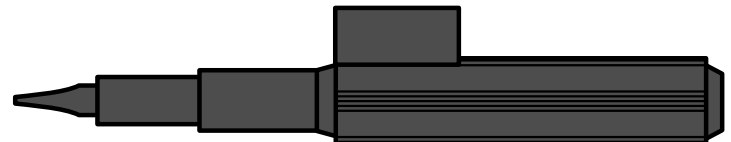

AVCS Gyro

Differences Between AVCS Gyro and Conventional Gyro

Compared to a conventional gyro, the AVCS gyro has a substantially improved tail control capacity. Gyro operation also differs from that of conventional systems in a number of ways.

The following sequentially describes the conventional gyro and the AVCS gyro.

Conventional gyro

The conventional gyro detects movement of the helicopter's tail and controls the rudder servo so that movement of the tail stops.

Now, consider hovering when the helicopter is exposed to a side wind, the tail drifts. When the tail drifts, the gyro detects the tail rotation angular velocity and operates the servo in the direction that stops the tail from moving. Drifting of the tail is stopped by control from the gyro. When the tail stops drifting, the control amount from the gyro becomes zero. Since the helicopter is always exposed to side wind, even in this state, the tail starts to drift again. When the tail drifts, the gyro tries to stop it again. The "drifting stop" operation is repeated and the tail continues to drift in the wind direction in this manner. The higher the gyro sensitivity, the smaller the amount of this drift. However, if the sensitivity is high, hunting will occur and, therefore, the sensitivity amp has a limit.

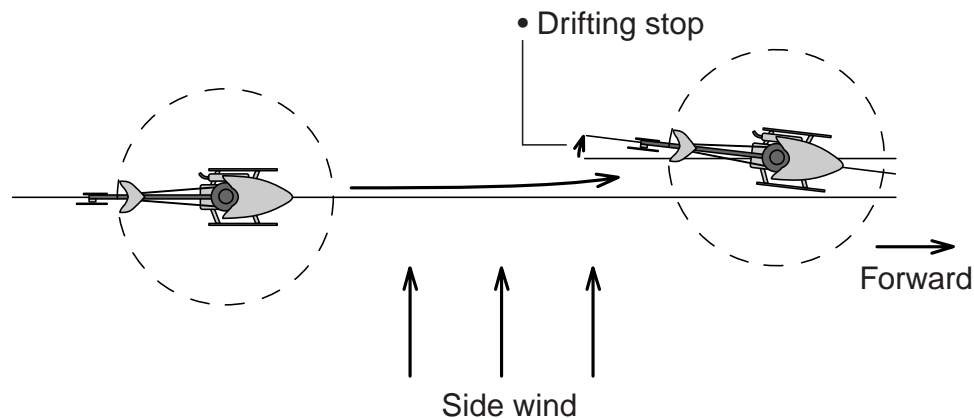

AVCS gyro

This following describes how the AVCS system works when the helicopter is exposed to a side wind while hovering, the same as the preceding item. When the helicopter is exposed to a side wind, the tail begins to drift. The

gyro controls the servo so that the movement of the tail stops, the same as a conventional gyro. At the same time, a sensor is controlled so that the tail is rotated in the opposite direction (returns to the original position). In short, the conventional gyro performs an operation known as "drifting stop", but the AVCS system performs an operation that "stops drifting and returns to original position". The "return to original position" operation added to the AVCS system improves rudder trim operation. In other words, the gyro can automatically trim the rudder against side winds. This also applies to reverse flight. When a helicopter is flying in the forward and reverse directions, the rudder trim is changed to advance, but with the AVCS system, this trim change is performed automatically and instantaneously so that the tail remains extremely stable even during high-speed reverse flight.

The AVCS system requires a high-precision angular velocity sensor. The GY501 realizes a high-precision angular velocity detection function and extremely small output drift by using a new type of gyro sensor. This minimizes rudder neutral position drift during flight and eliminates the need to trim the rudder during flight.

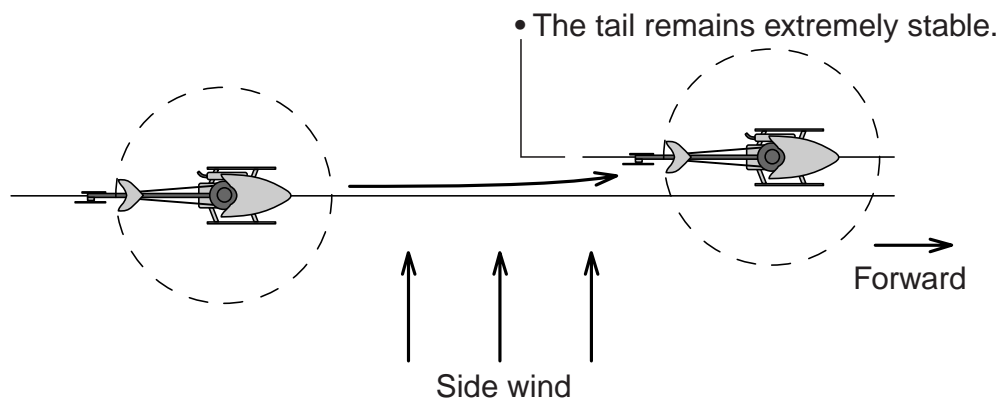

Differences in rudder control method

The following describes the differences between conventional gyro and AVCS gyro rudder control.

The conventional gyro sends the rudder control signals from the transmitter to the rudder servo and starts to move the tail. When the tail moves, the gyro detects this movement and generates a signal to stop it. If the tail continues to move even in this state, a rudder control signal larger than the signal from the gyro must be applied from the transmitter. That is, the difference between the rudder control signal from the transmitter and the control signal that attempts to stop this from the gyro becomes the actual amount of movement of the tail. Ordinarily, the rudder control signal is amplified

several times over by the gyro amp and is balanced with the gyro control signal so that the transmitter can be used at the normal steering angle.

The AVCS system uses a different rudder control method. As described in the preceding section, it has additional functions that "attempt to return movement by external force to the original position" and that generate an angular velocity proportional to the rudder control signal. That is, it functionally controls the speed of rotation of the tail. The original AVCS (Angular Vector Control System) came from this.

- In the AVCS mode, when the transmitter rudder stick is moved when the helicopter was stopped, the rudder servo controls operation until the tail reaches the specified rotational speed.
- Trim deviation of the rudder control signal also becomes a signal that causes the tail to turn so that even a little trim deviation causes the tail to move. Therefore, the rudder trim is made the same in all flight states and must match the neutral reference signal at the gyro. The method of reading the rudder neutral signal at the gyro will be described separately.
- Since the rudder mixing signals from the transmitter also become a tail rotation signal, all the rudder mixing functions must be disabled.
- In the AVCS mode, the gyro automatically trims the rudder so that linkage changes cannot be verified. Initially, the GY502 trims the rudder by flying in the Normal mode to take the rudder linkage neutral position. This centers the linkage. At this time, this rudder neutral reference point is read to the GY502.

Giving the gyro the rudder neutral reference signal and performing tail operation by referring to this signal in the AVCS mode in this way is how the AVCS system differs from the conventional system.

Digital Servo Compatibility

Gyro performance largely depends on the servo used. The GY502 displays top performance when used with a digital servo.

When using a digital servo, set the servo frame rate (Frm) function to High.

(For a description of the setting method, see page 19.)

DATA SETTING

Name and Function of Each Part

GY502 control amp

LCD display

Displays the set data. (8 characters X 1 line)

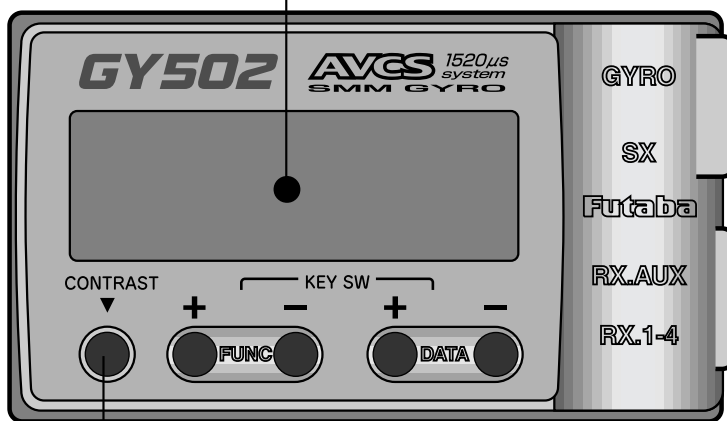

(Input/output terminals)

Gyro sensor input

Rudder servo output

(Receiver connectors)

Remote gain input

Rudder input

Edit keys

Used when setting data.

Operated by pushing with the accessory mini screwdriver.

LCD contrast trimmer

Allows adjustment of the contrast so that the LCD display is easiest to see.

It is adjusted with the accessory mini screwdriver.

GY502 gyro sensor

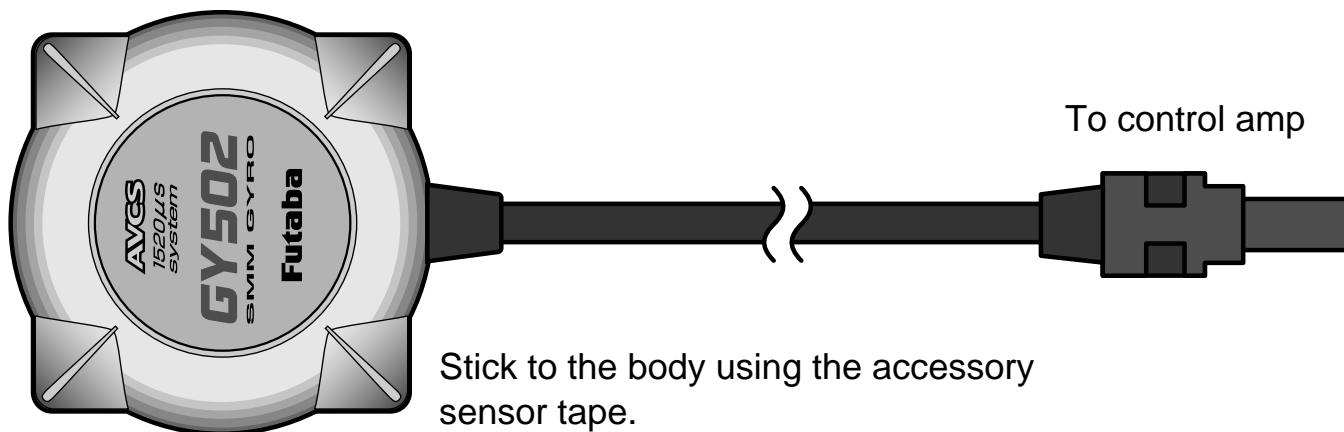

Stick to the body using the accessory sensor tape.

LCD Display and Edit Keys

LCD display

Set data display and operation status monitoring are possible.

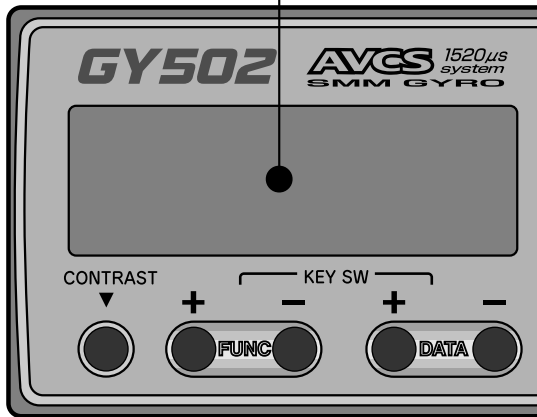

Edit keys

Setup screen call

The setup screens can be sequentially called with the FUNC+ or FUNC- key. For the order in which the setup screens are called, see the function map.

Data setting

Perform data setting with the DATA+ or DATA- key. When setting a value, the data is increased when the DATA+ key is pressed and is decreased when the DATA- key is pressed. The mode can also be selected using either the DATA+ or the DATA- key.

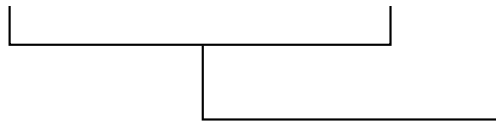

Function Map

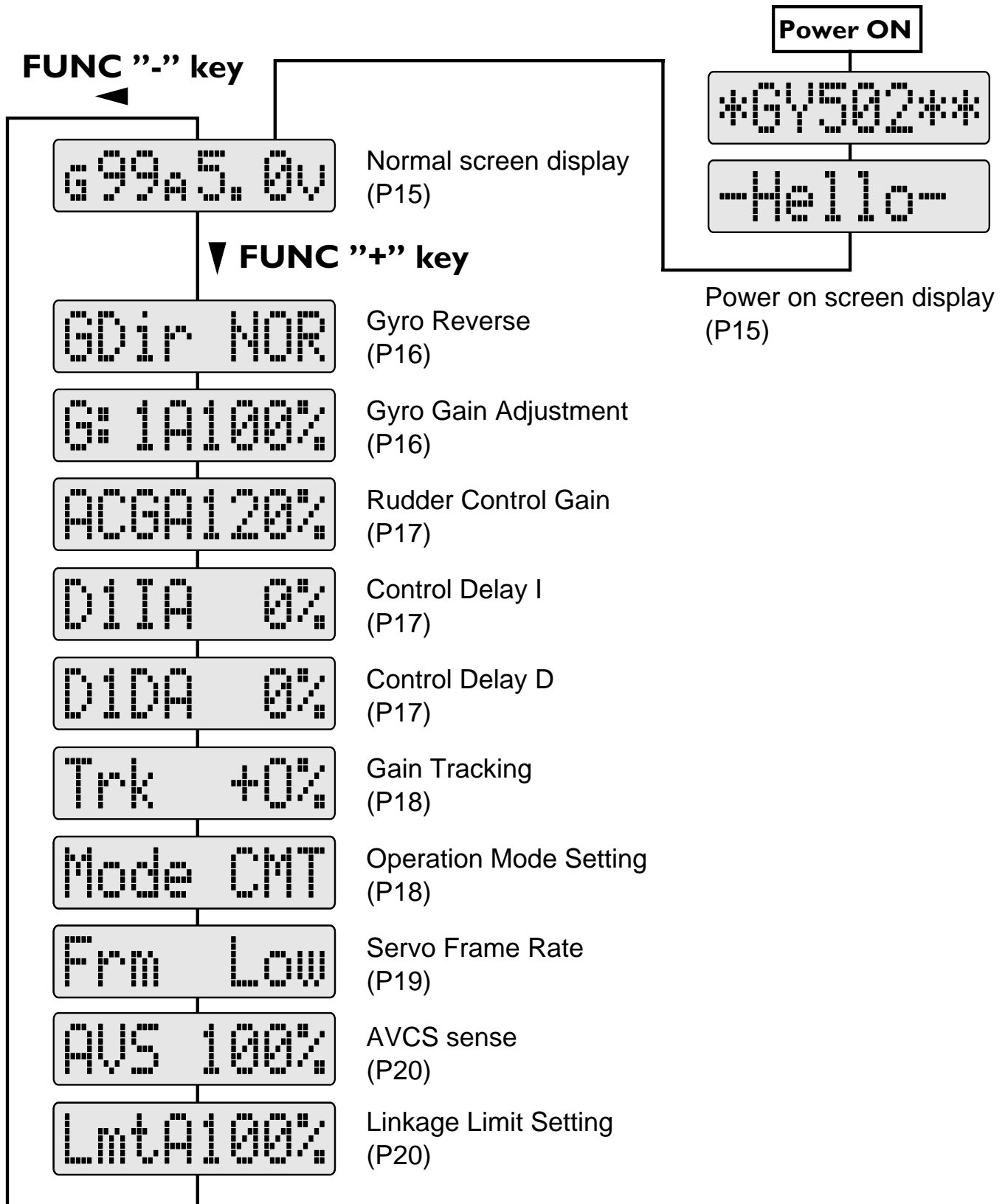

GY502 Functions Setting

Power on screen display

*GY502**

-Hello-

When the gyro power is turned on after the transmitter power was turned on, -Hello- blinks for about three seconds to initialize the data inside the gyro. During this period, do not move the transmitter rudder stick or the helicopter. If the transmitter rudder stick or the helicopter is moved by mistake, the rudder neutral data will not be correctly read.

Normal screen display

g99A5.0v

- Actual gain (sensitivity) display

- Operation mode display

N : NOR mode

A : AVCS mode

■ : Neutral offset

- Power supply voltage display

- During rudder neutral reset operation, **** is displayed.

- During rudder servo reset operation by rudder stick, ---- is displayed.

Low Batt

Low battery alarm

When the power supply voltage drops to 3.8V or less, LOW Batt is displayed. When this message is displayed, immediately stop use and recharge the Nicd battery.

Gyro Reverse

Initial value: NOR

A rectangular LCD display with a black border showing the text "GDir NOR" in a pixelated font.

Sets the gyro operation direction. NOR or REV can be selected.

Set so that when the helicopter is banked right, left correction rudder is applied and when the helicopter is banked left, right correction rudder is applied.

Gyro Gain Adjustment

Initial value: 100%

A rectangular LCD display with a black border showing the text "G: 1A100%" in a pixelated font.

Adjusts the gyro gain. Setting range is 0 to 120%.

Two-point (G:1, G:2) gain adjustment is possible. When A is displayed, the gyro is in the AVC mode and when N is displayed, the gyro is in the NOR mode in accordance with the operation mode setting.

Rudder Control Gain

Initial value : ACG: 100%, NCG: 120%

A digital display showing the text "ACGA100%" in a pixelated font, enclosed in a rectangular border.

Adjusts the rudder stick operation gain. Setting range is 10% to 250%.

AVCS and NOR mode gain can be set independently. In the AVCS mode, ACG is displayed and in the NOR mode, NCG is displayed. The display automatically changes to A or B according to the direction of the rudder stick and the gain of each direction can be set. This function is used when tracking rudder operation gain between the AVCS and NOR modes.

Control Delay I

Initial value : 0%

A digital display showing the text "D1IA 0%" in a pixelated font, enclosed in a rectangular border.

Sets the delay when the rudder stick was pushed operated. Setting range is 0 to 100%. Rudder stick left and right can be set separately.

Control Delay D

Initial value : 0%

A digital display showing the text "D1DA 0%" in a pixelated font, enclosed in a rectangular border.

Sets the delay when the rudder stick was returned. Setting range is 0 to 100%. Rudder stick left and right can be set separately.

Gain Tracking

Initial value : +0%

A rectangular LCD display with a black border showing the text 'Trk +0%' in a pixelated font.

Adjusts left and right tail braking tracking. Setting range is -20% to +20%.

For example, when there is a sense of hunting when stopping left pirouette or the helicopter drifts when stopping right pirouette, shift Trk in the + direction. In the opposite case, shift Trk in the - direction.

Operation Mode Setting

Initial : CMT

A rectangular LCD display with a black border showing the text 'Mode CMT' in a pixelated font.

Sets the gyro operation mode. Settings are NOR, AVC, and CMT. In the NOR mode, both G1 and G2 operate in the AVCS mode. In the CMT mode, G1 operates in the AVCS mode and G2 operates in the NOR mode. In the NOR mode, the GY502 operates the same as an ordinary gyro. In the AVC mode, the GY502 always operates in the AVCS mode. In the CM mode, the GY502 can be used in both the AVCS and NOR modes.

Servo Frame Rate

Initial value : Low



Switches the servo output pulses.

The Low mode outputs pulses for an ordinary servo. Switch to the High mode only when using a digital servo.

⚠ Caution

- ⊘ **When using a servo that cannot be driven by high-speed pulses, other than a digital servo, never set servo frame rate to the High mode.**

The servo may be destroyed.

AVCS Sense

Initial value : 100%

A rectangular box with a thin black border containing the text "AVS 100%" in a pixelated, monospace font.

Adjusts the rudder control characteristic in the AVCS mode. Setting range is 50 to 150%.

Adjust by checking the rudder operation feel and stopping characteristic.

Linkage Limit Setting

Initial value : 100%

A rectangular box with a thin black border containing the text "LmtA100%" in a pixelated, monospace font.

Sets the rudder servo travel limit.

Operate the rudder stick and adjust the rudder servo travel limit by pressing the +/- key so that the servo moves to the maximum linkage position. Use the same procedure to set both the left and right limits . When setting, move the servo substantially so that the rudder angle automatically becomes 200% and limit setting is easy. A or B is displayed for the right and left directions.

Note: When this screen is displayed, the GY502 does not operate as a gyro. To check operation, return to the initial screen, etc.

Remote Gain Function

The remote gain function lets operator perform AVCS mode and Normal mode sensitivity adjustment and operation mode switching from the transmitter. The channel used here is called the "remote gain channel". (Channel 5 is used.)

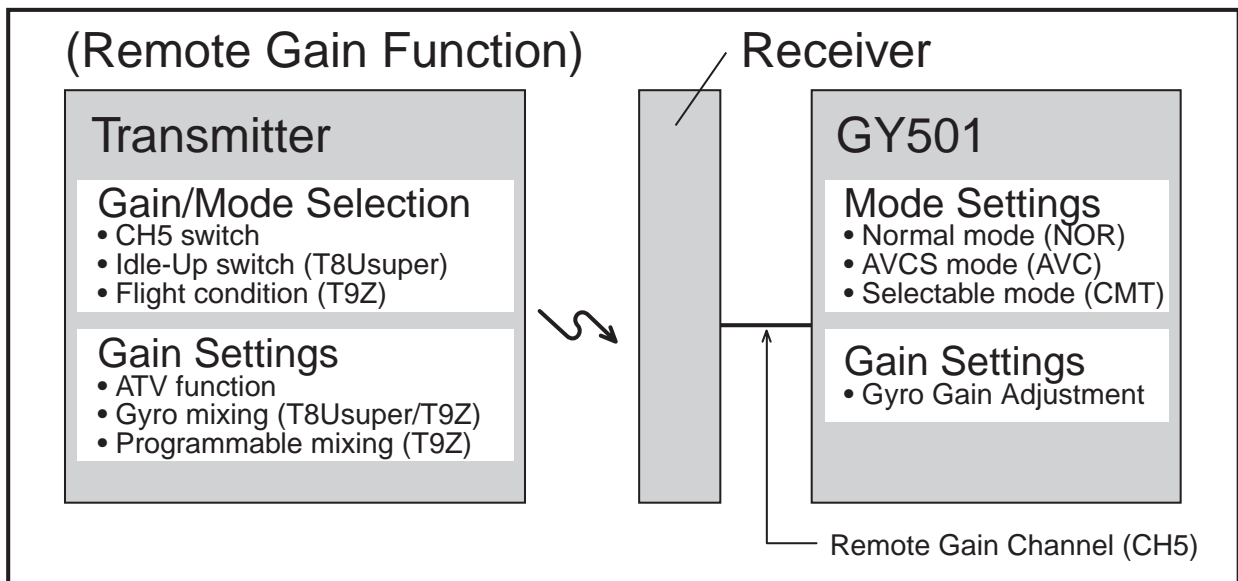

When Using a T9Z World Champion Model Transmitter Gyro Sense Mixing

The Gyro Sense Mixing (GYR) function lets operator perform two-point gain adjustment at each condition. Set the sensitivity at all conditions.

[GY502 Settings]

Select the gyro operation mode at the GY502 Mode screen. (AVC, NOR, or CMT)

[Transmitter Settings]

ATV function:

Adjust both the RATE A and RATE B rates to 100% at the transmitter ATV function setup screen.

Gyro Sense Mixing function:

1. Select the Dual Mode (DUO) at the transmitter Gyro Sense Mixing setup screen.
2. Set the GAIN1 and GAIN2 gains.

(The following page shows a setting example in the CMT mode.)

[Sensitivity Display]

The gain display indicates the actual gain at the GY502 normal screen display.

The following shows the relationship between transmitter and gyro setting when GY502 sensitivity setting is 100% in both the G1 and G2 gain modes.

- Relationship between transmitter and gyro setting

Transmitter settings	GAIN1 GAIN2	0%	-	50%	-	100%
GY502mode settings	NOR	Normal mode				
	AVC	AVCS mode				
	CMT	Normal mode (G2)		AVCS mode (G1)		
Actual gain		100%	-	0%	-	100%

(Setting Example)

Adjust the gyro gain at the Gyro Sense Mixing setup screen at each condition.

The following shows a setting example in the CMT mode.

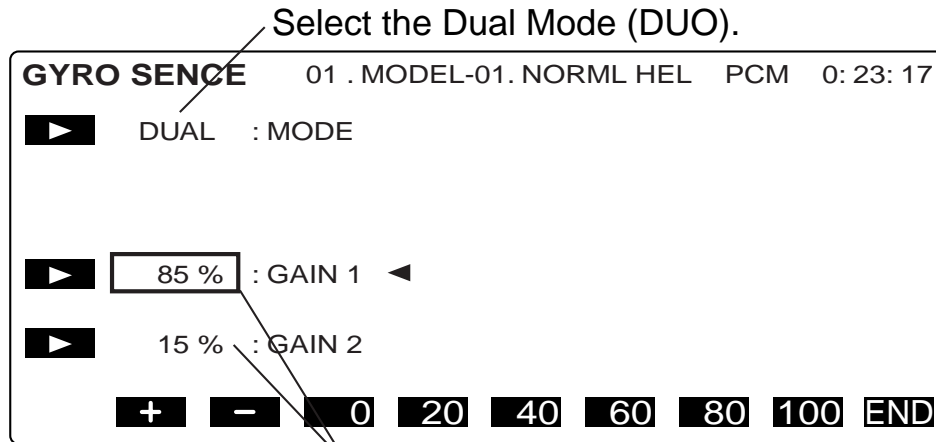



Sensitivity rate

Choose the GAIN1 or GAIN2 by the CH5 switch.

Use the following values as the sensitivity setting standard:

CH5 switch

	GAIN1 setting	Hovering	Flight	AVCS side
		85%	70%	
	GAIN2 setting	15%	30%	Normal side
	Actual gain	70%	40%	

The GY502 sensitivity is 0% at 50%. When set over 50%, the GY502 operates in the AVCS mode and when set under 50%, the GY502 operates in the Normal mode. When setting is changed 1%, the gyro sensitivity is changed 2%.

When Using a T9Z Transmitter Programmable Mixing

The Programmable Mixing (PMIX) function lets operator perform a gain adjustment at each condition. Set the sensitivity at all conditions.

[GY502 Settings]

Select the gyro operation mode at the GY502 Mode screen. (AVC, NOR, or CMT)

[Transmitter Settings]

Function Control:

Set the CH5 (GYR) switch to “NUL” at the transmitter Function Control (FNC) setup screen.

ATV function:

Adjust both the RATE A and RATE B rates to 120% at the transmitter ATV function setup screen.

Programmable Mixing function:

1. Select the “ACTIVE” mode (ACT) at the transmitter Programmable Mixing setup screen.
2. Set the mixing type to “OFS”.
3. Set the slave channel to “GYR”.
4. Set the sensitivity rate (RATE).

(The following page shows a setting example in the CMT mode.)

[Sensitivity Display]

The gain display indicates the actual gain at the GY502 normal screen display.

The following shows the relationship between transmitter and gyro setting when GY502 sensitivity setting is 100% in both the G1 and G2 gain modes.

- Relationship between transmitter and gyro setting

Transmitter settings		-100%	-	0%	-	+100%
GY502mode settings	NOR	Normal mode				
	AVC	AVCS mode				
	CMT	Normal mode (G2)		AVCS mode (G1)		
Actual gain		100%	-	0%	-	100%

(Setting Example)

Adjust the gyro gain at the Programmable Mixing setup screen at each condition. The following shows a setting example in the CMT mode.

Select the "ACTIVE".

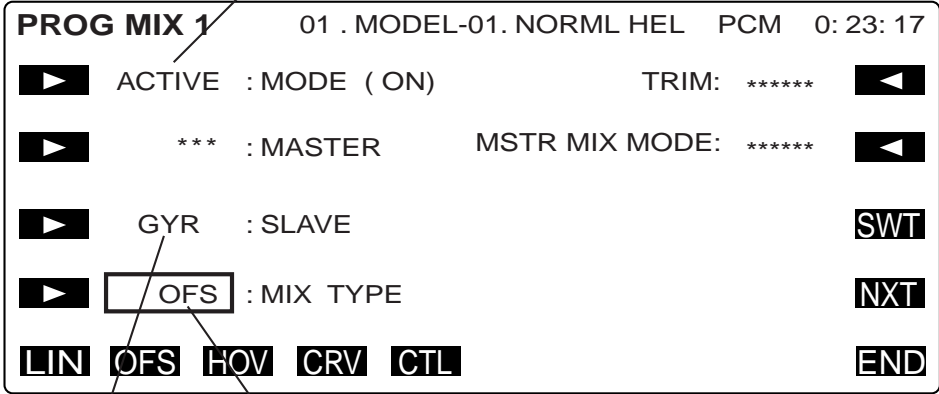

Select the "GYR".

Select the "OFS".

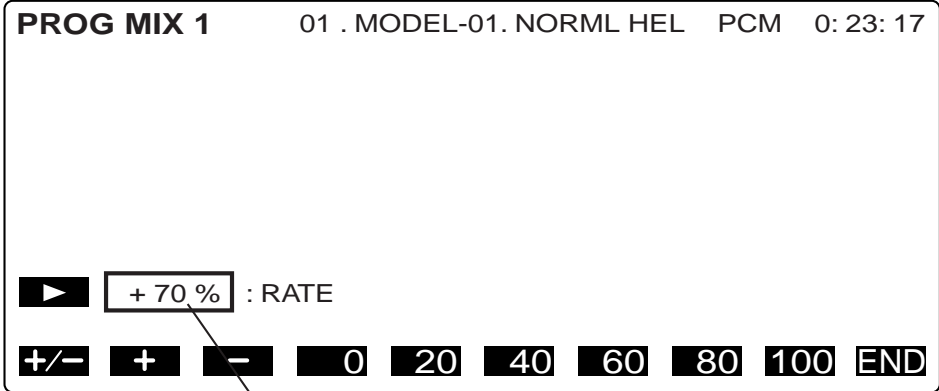

Sensitivity rate

Use the following values as the sensitivity setting standard:

		Hovering		Flight
AVCS mode	——	+70%	——	+40%
Normal mode	——	-70%	——	-40%
	Actual gain	70%		40%

When set over 0%, the GY502 operates in the AVCS mode and when set under 0%, the GY502 operates in the Normal mode.

When Using a T8Usuper Transmitter

The Gyro Mixing (GYRO) function lets operator perform a gain adjustment at each Idle-Up switch position.

[GY502 Settings]

Select the gyro operation mode at the GY502 Mode screen. (AVC, NOR, or CMT)

[Transmitter Settings]

Gyro Mixing function:

1. Select the "ON" mode at the transmitter Gyro Mixing (GYRO) setup screen.
2. Select the Idle-Up switch(SW-E) for the sensitivity selection.
3. Set the "NORM", "IDL1" and "IDL2" gains.

(The following page shows a setting example in the CMT mode.)

[Sensitivity Display]

The gain display indicates the actual gain at the GY502 normal screen display.

The following shows the relationship between transmitter and gyro setting when GY502 sensitivity setting is 100% in both the G1 and G2 gain modes.

- Relationship between transmitter and gyro setting

Transmitter settings	NORM				
	IDL1	0%	-	50%	-
GY502mode settings	IDL2				
	NOR	Normal mode			
	AVC	AVCS mode			
	CMT	Normal mode (G2)		AVCS mode (G1)	
Actual gain	100%	-	0%	-	100%

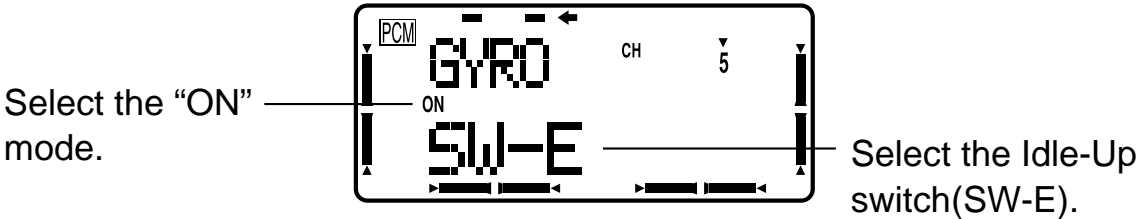

(Setting Example)

Adjust the gyro gain at each the Idle-Up switch position at the Gyro Mixing setup screen. The following shows a setting example in the CMT mode.



Set the "NORM", "IDL1" and "IDL2" gains at each setup screen.

Use the following values as the sensitivity setting standard:

	(NORM)	(IDL1)	(IDL2)
SW-E			
	Hovering	Flight	
AVCS mode	———— 85%	————	70%
Normal mode	———— 15%	————	30%
Actual gain	70%	40%	

When set over 50%, the GY502 operates in the AVCS mode and when set under 50%, the GY502 operates in the Normal mode.

When Using a Transmitter ATV Function

The ATV function lets operator perform a gain adjustment at each CH5 switch position.

[GY502 Settings]

Select the gyro operation mode at the GY502 Mode screen. (AVC, NOR, or CMT)

[Transmitter Settings]

ATV function:

Set the ATV rates at the transmitter CH5 ATV function.

[Sensitivity Display]

The gain display indicates the actual gain at the GY502 normal screen display.

The following shows the relationship between transmitter and gyro setting when GY502 sensitivity setting is 100% in both the G1 and G2 gain modes.

- Relationship between transmitter and gyro setting

		CH5 Switch Forward side		CH5 Switch Front side		
Transmitter settings	ATV rates	90%	-	0%	-	90%
GY502mode settings	NOR	Normal mode		Normal mode		
	AVC	AVCS mode		AVCS mode		
	CMT	Normal mode		AVCS mode		
		(G2)		(G1)		
Actual gain		100%	-	0%	-	100%

When Using a GY502 Gyro Gain Adjustment Function

[Transmitter Settings]

Adjust both the ATV rates to 90% at the transmitter Ch5 ATV function.

[GY502 Settings]

Operation Mode Setting function:

Select the gyro operation mode at the GY502 Mode screen. (AVC, NOR, or CMT)

Gyro Gain Adjustment function:

Set the G:1 and G:2 gains at the GY502 G:x screen.

- Relationship between transmitter and gyro setting

Transmitter settings	ATV rates	CH5 Switch	CH5 Switch			
		Forward side	Front side			
		90% (Fixed)	90% (Fixed)			
GY502mode settings	NOR	Normal mode	Normal mode			
	AVC	AVCS mode	AVCS mode			
	CMT	Normal mode	AVCS mode			
		(G2)	(G1)			
Actual gain		100%	-	0%	-	100%

Initialization

AVCS mode operation is based on the rudder neutral data stored in the GY502. When using the GY502 for the first time, or when the internal reference data and the transmitter neutral position differed when the transmitter neutral trim was adjusted, etc., the rudder neutral data must be read again.

[At power ON]



When the power switch is turned on, the GY502 automatically obtains the reference signal for AVCS function correction and initializes itself.

- When the power was turned on in the Normal mode, the rudder neutral position already memorized in the GY502 is not updated.
- When the power was turned on in the AVCS mode, the rudder signal at that point is memorized and updated.

Caution

Precautions When Turning on the Power Switch

During initialization, the message “-Hello-” appears on the GY502 LCD screen.

-  **Do not move the helicopter until this message disappears (in about 3 seconds).**
-  **Also, do not move the transmitter rudder stick from the neutral position during this period.**

[During use]



When the rudder was re-trimmed in the Normal mode and the new trim position also affects the AVCS mode, the rudder trim neutral position must be memorized in the GY502.

Re-reading method

In this case, quickly switch (interval of within 1 second) the transmitter remote gain switch between the Normal and AVCS sides at least three times and switch the AVCS side at the neutral trim position set in the Normal mode. This memorizes the new rudder neutral position in the GY502.

When the transmitter has a function that allows trim setting for each flight condition, such as the T9Z, the AVCS mode trim position is fixed and this operation is unnecessary.

Caution

-  **Never use the transmitter rudder trim in the AVCS mode.**
When the rudder is trimmed during flight, the neutral position will change.
-  **When using the GY502 in the AVCS mode, set revolution mixing to OFF.**
-  **When the rudder neutral position was changed by the linkage, the rudder neutral position in the AVCS mode must always be re-read before use.**

INSTALLATION AND ADJUSTMENT

Install and adjust the GY502 as described below.

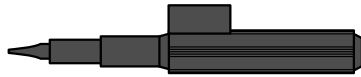

- When making GY502 adjustments, always use the accessory miniature screwdriver and do not apply excessive force.

Installing to Fuselage

I Installing sensor and amp

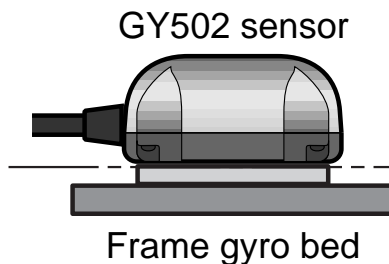

- Install the sensor so that the bottom of the gyro is perpendicular to the main rotor shaft axial direction. Offset of this axis will also react in the roll and pitch directions.

Install the GY502 sensor to the fuselage using the accessory sensor tape. Also routinely check the sensor tape and replace the tape if it is saturated with oil or partially peeled.

*Oil on the sensor bottom and the part installed to the frame can be wiped off with cleaner, etc.

Sensor installation precautions

- Always use the accessory sensor tape to install the sensor. Install the sensor to the center of the sensor tape.
- Depending on the vibration from the helicopter, the sponge may tear near the corners of the sensor tape. If the helicopter is flown in this state, vibrations will not be sufficiently absorbed and the sensor may fall off. Before flight, always check the sensor installation state. If the sponge is torn, replace it.

Installing control amp

- When installing the control amp, after the end of sensitivity adjustment, vibration-proof the amp by wrapping it in sponge, the same as the receiver.

2 Connections

Connect the GY502, receiver and servo as shown below.

⚠ Warning

❗ **Insert the connectors fully and firmly.**

If a connector works loose due to vibration during flight, control may be lost and result in a dangerous situation.

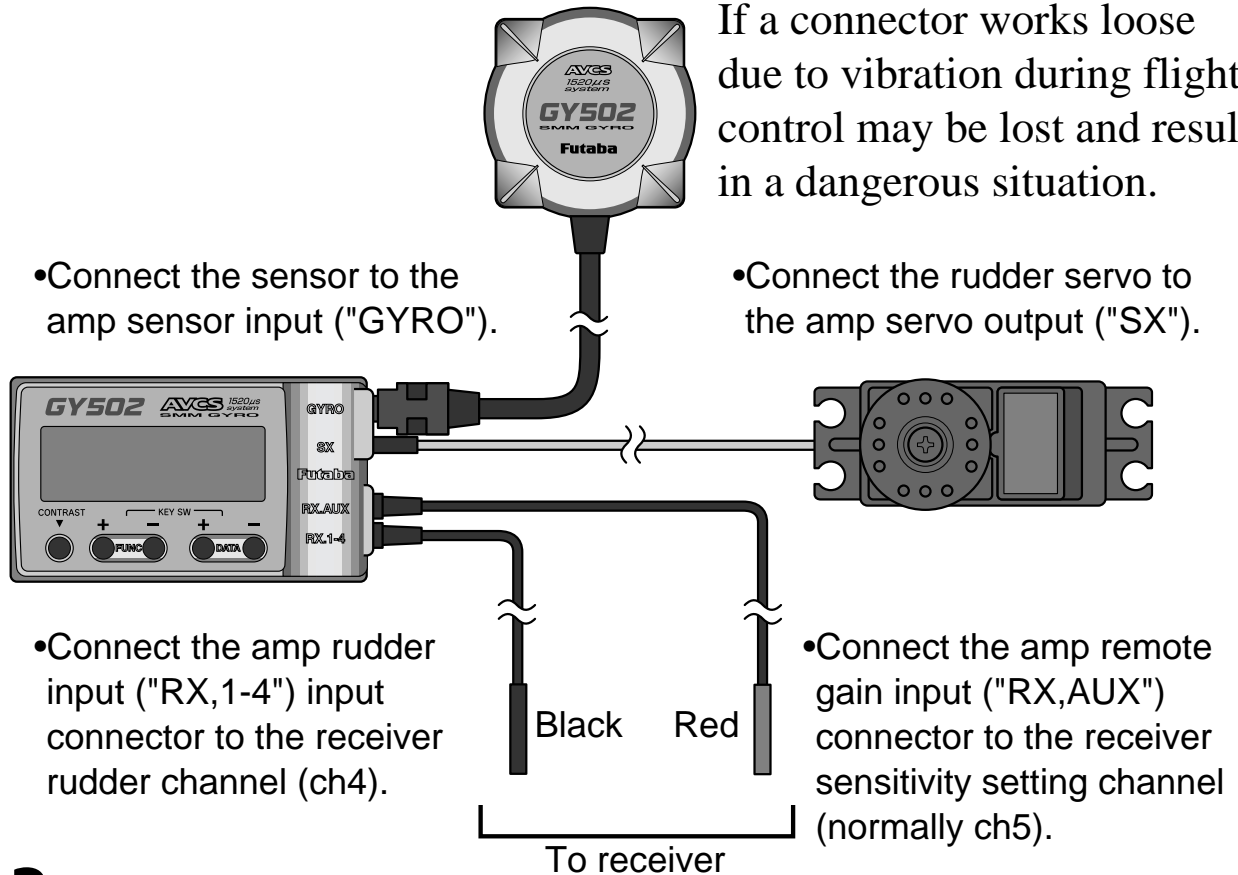

3 Servo selection

When using a digital servo (S9253, S9250, S9450, etc.) as the rudder servo, select High at the Frm screen.



When using a servo other than a digital servo, select Low at the Frm screen.

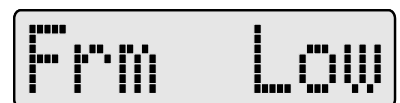

4 Gyro operation mode selection

When using the gyro only in the NOR mode, select NOR. When using the gyro only in the AVCS mode, select AVCS. When using the gyro in both the AVCS and NOR modes, select CMT.



*However, when using the gyro in the CMT mode, since the AVCS and NOR mode gain must be set during hovering and in flight, a transmitter with a gyro mixing function (T9Zwc series, T8Usuper series) is necessary.

- For a description of transmitter setting, see the remote gain function (p21).

5 Rudder servo linkage check

Make the initial linkage connections in the NOR mode. In this case, make adjustments mechanically and make minimum trimmer adjustments at the transmitter.

In the NOR mode, make the following linkage checks:

- In the rudder neutral position, connect the linkage at the position at which the servo horn and control wire are perpendicular.

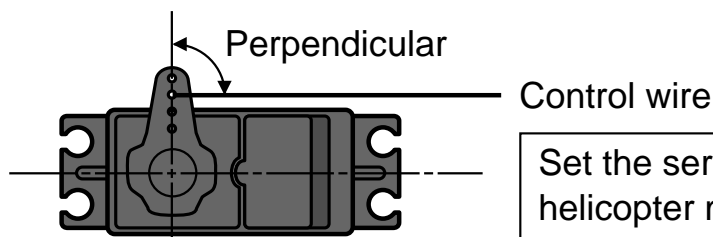

Set the servo horn length based on the helicopter manufacturer's instructions.

Move the rudder stick to the right and left and check the direction of operation of the tail rotor. If the tail rotor turns in the wrong direction, reverse the direction with the transmitter reverse function.

6 Gyro operation direction check

If the rudder servo moves to the left when the nose of the helicopter moves to the right, the gyro direction is correct.

If the rudder servo moves to the right, switch the direction using the GDir screen.



*If you try to fly the helicopter while the gyro direction is incorrect, when the rotor rotates clockwise, the helicopter nose will yaw to the left and cause an extremely dangerous situation.

7 Limit setting

Move the rudder stick to the left and right and perform adjustment at the Lmt screen so that the servo operation angle becomes the maximum value at which the servo horn does not strike the linkage.

*When flying, the servo horn does not move beyond this set angle, thus protecting the linkage. However, if the limit setting is too low, gyro performance will be effected.

*In this mode, only the stick operates; the gyro does not operate.

8 Gyro gain setting (tentative setting)

The initial gain of the GY502 is 100% for both G1 and G2. When setting the gain from the transmitter, leave it at the 100% reference gain.

Make the following value the gain setting criteria.

A setting example when a T9Zwc series transmitter was used is described below. When using another transmitter, see "Remote gain function" on page 21.

(T9Zwc transmitter setting)

- Call the transmitter GYR setting screen.
- Adjust the gain when hovering to 90% at the AVCS side and 10% at the normal side on the transmitter screen.
- Set the gain in flight to 80% and 20% for the AVCS and NOR mode, respectively, on the transmitter screen.
- At this time, the GY502 gain display becomes 80% for hovering and 60% for flight.

(*1) In the case of the T9Z GYR function, GY502 gain is 0% for a transmitter setting of 50%. When the gain is set above 50%, the GY502 operates in the AVCS mode and when the gain is set below 50%, the GY502 operates in the normal mode. The gyro gain changes 2% for every 1% gain change.

When using a transmitter without a gyro gain switching function, connect the gain setting connector to an idle channel and set the GY502 G1 and G2 gains using this gain setting screen. Gain can be trimmed by means of the transmitter ATV function.

9 Transmitter setting check

Checks the transmitter setting in the ACVS mode. Check that the transmitter is not set so that the neutral position has shifted.

(Transmitter setting)

- Set all rudder mixings to INH.
- Set all hovering and flight rudder trims to the same position.
- Set rudder ATV to 100% under all conditions.
- Also set the T9Z condition delay function to INH.

If the normal screen operation mode display is “A” under all usage conditions, neutral offset is OK. If “■” is displayed, display “A” by operating the rudder trimmer for that flight condition.

10 Rudder neutral position check

In the AVCS mode, the rudder servo neutral position is unknown. Check the neutral position by switching the GY502 to the NOR mode, or by moving the rudder stick to the left and right at least three times at high speed and immediately returning the stick to the neutral position. This temporarily resets the rudder servo.

Flight Adjustments

1 In the AVCS mode, turn on the transmitter power, then turn on the gyro and receiver power. This reads the rudder neutral signal at the GY502.

- Never move the helicopter or rudder stick during the approximately three seconds that the -Hello- display blinks.

2 Hover in the Normal mode and adjust the rudder neutral position.

- In the AVCS mode, the rudder neutral position is automatically set, and linkage changes cannot be verified. First, perform rudder neutral adjustment in the Normal mode.
- Move the transmitter trim lever and reset the neutral position. When the rudder servo neutral position has changed considerably, readjust the linkage.

3 When the transmitter rudder trim was adjusted, the rudder neutral data must be read to the GY502. Therefore, always perform the following operations:

- Switch the transmitter sensitivity switch quickly (internal of within 1 second) between AVCS and Normal at least three times. "*****" is displayed on the LCD screen to show that data is being memorized. During this operation, never move the transmitter rudder stick from the neutral position for at least 1 second immediately after switching the switch in the state in which the model is on the ground. Memorization and updating is executed only when the sensitivity switch is in the AVCS mode position.

4 Set the sensitivity to the position at which hunting does not occur during hovering and flight.

- When the helicopter tail hunts, set the gyro sensitivity to a lower value. When adjusting the gyro sensitivity, increase and decrease the sensitivity gradually while checking.

5 Adjust the hovering and flight rudder effect using the transmitter's D/R or AFR function.

- Do not adjust with the ATV function. If the ATV function is used, trimming may change.

(If necessary)

6 When you sense a difference in the rudder effect between the AVCS and Normal modes, adjust using the GY502 rudder control gain.

NCGA1 30%

- Adjustment method

When the rudder effect in the AVCS is different from the rudder effect in the Normal mode after adjustment was performed using the transmitter's D/R or AFR function, adjust the difference using the NCGx parameter.

7 Adjust the left and right pirouette stopping state by control delay and tracking.

D11A 0%

D1DA 0%

Trk +0%

- Adjustment using the delay function of the T9Z transmitter is also possible. Since the gyro gain also has a large effect on the stopping state, make this adjustment after adjusting the sensitivity.

8 Adjust the rudder operation feel using the GY502 AVCS sense in the AVCS mode.

(Steering angle, neutral suppression, and pirouette stopping)

AVS 100%

9 When you want to use rudder mixing in the Normal mode, set the transmitter so that rudder mixing is applied only during Normal mode operation. Never use rudder mixing in the AVCS mode.

REFERENCE

Specifications

* Specifications are subject to change without prior notice.

GY502 Ratings

Yaw-axis stabilizer for helicopter (rate gyro)

Display device: 8-character dot matrix liquid crystal display

Operating voltage range: DC 3.8V to 6.0V

Current drain: 70mA (@5.0V, including sensor)

Operating temperature range: -10 to +50 degree C

Operating humidity range: 10 to 90%RH (no condensation)

Dimensions: 57 x 32 x 15mm (amp), 34 x 34 x 16.5mm (sensor)

Weight: 34g (amp) + 25g (sensor)

Definition of Abbreviations

The following defines the abbreviations and symbols used in this manual in alphabetical order. The function names are given on the description pages.

A		I	
ACGA/B	Rudder control gain (AVCS) p17	IDLE	Transmitter power OFF state.
AFR	AFR function.	INH	Use inhibited state.
ATV	ATV function. Steering angle adjustment function.	L	
AVC	AVCS mode.	LCD	Liquid crystal display screen.
AVCS	AVCS system. AVCS mode.	LmtA/B	Linkage limit setting. p20
AVS	AVCS sense. p20	Low	Low side.
C		LOW BAT	Low battery error display.
CMT	Normal/AVC switching mode.	M	
D		Mode	Operation mode setting. p18
D1DA	Control delay. p17	N	
D1IA	Control delay. p17	NCGA/B	Rudder control gain (Normal) p17
D/R	Dual rate function.	NOR	Normal mode. Normal side.
DUO	T9Z dual gain control mode.	P	
F		PMIX	Programmable mixing.
Frm	Servo frame rate. p19	R	
G		REV	Reverse side.
G:1A/N	Gyro gain 1 side. p16	T	
G:2A/N	Gyro gain 2 side. p16	Trk	Gain tracking. p18
GDir	Gyro reverse. p16	H	
GYRO	T9Z gyro sense mixing.	Hello	Power on screen display.
H		High	High side.

GY502 Parameters Sheet

* Copy and use.

Helicopter: _____

Date: _____

Parameter		Initial value	Set value	Remarks
GDir Gyro Reverse		NOR		NOR/REV
G:xx Gyro Gain Adjustment	G:1 G:2	100% 100%		0-120% 0-120%
ACGx, NCGx Rudder Control Gain	ACGA ACGB NCGA NCGB	100% 100% 120% 120%		10-250% 10-250% 10-250% 10-250%
D1Ix Control Delay I	D1IA D1IB	0% 0%		0-100% 0-100%
D1Dx Control Delay D	D1DA D1DB	0% 0%		0-100% 0-100%
Trk Gain Tracking		+0%		-20-+20%
Mode Operation Mode Setting		CMT		CMT/NOR/AVC
Frm Servo Frame Rate		Low		Low/High
AVS AVCS Sense		100%		50-150%
Lmtx Linkage Limit Setting	LmtA LmtB	100% 100%		

FUTABA CORPORATION

Makuhari Techno Garden Bldg., B6F 1-3 Nakase, Mihama-ku, Chiba 261-8555, Japan
Phone: (043) 296-5118 Facsimile: (043) 296-5124

©FUTABA CORPORATION 2000, 9